

- 1. Golden Lemon (Mar:1003)
- 2. Aqua Sun (Mar:1109)
- 3. Copper (Mar:1137)
- 4. Leaden Gray (Mar:1320)
- 5. Off White (Mar:1181)
- 6. Cinnamon Sand (Mar:1183)

Design1-10 Inches.pes
9.65x6.61 inches; 57,189 stitches
6 thread changes; 6 colors

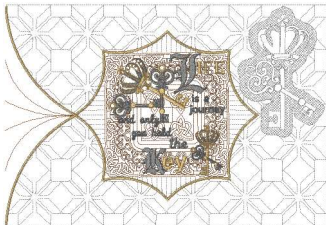

- 1. Golden Lemon (Mar:1003)
- 2. Aqua Sun (Mar:1109)
- 3. Copper (Mar:1137)
- 4. Leaden Gray (Mar:1320)
- 5. Off White (Mar:1181)
- 6. Cinnamon Sand (Mar:1183)

Design1-12 Inches.pes
11.61x7.96 inches; 64,989 stitches
6 thread changes; 6 colors

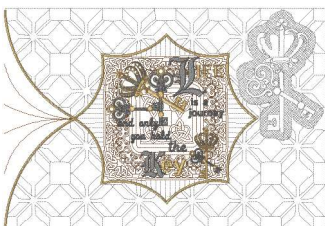

- 1. Golden Lemon (Mar:1003)
- 2. Aqua Sun (Mar:1109)
- 3. Copper (Mar:1137)
- 4. Leaden Gray (Mar:1320)
- 5. Off White (Mar:1181)
- 6. Cinnamon Sand (Mar:1183)

Design1-13 Inches.pes
12.99x8.91 inches; 71,190 stitches
6 thread changes; 6 colors

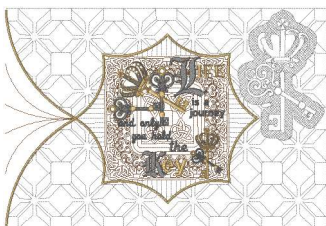

- 1. Golden Lemon (Mar:1003)
- 2. Aqua Sun (Mar:1109)
- 3. Copper (Mar:1137)
- 4. Leaden Gray (Mar:1320)
- 5. Off White (Mar:1181)
- 6. Cinnamon Sand (Mar:1183)

Design1-14 Inches.pes
13.58x9.31 inches; 73,752 stitches
6 thread changes; 6 colors

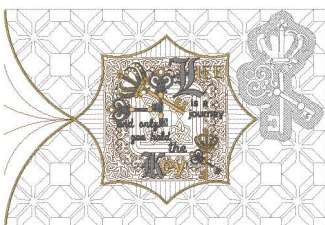

- 1. Golden Lemon (Mar:1003)
- 2. Aqua Sun (Mar:1109)
- 3. Copper (Mar:1137)
- 4. Leaden Gray (Mar:1320)
- 5. Off White (Mar:1181)
- 6. Cinnamon Sand (Mar:1183)

Design1-16 Inches.pes
15.55x10.66 inches; 82,688 stitches
6 thread changes; 6 colors



- 1. Golden Lemon (Mar:1003)
- 2. Aqua Sun (Mar:1109)
- 3. Copper (Mar:1137)
- 4. Leaden Gray (Mar:1320)
- 5. Off White (Mar:1181)
- 6. Cinnamon Sand (Mar:1183)

Design1-9 Inches.pes
8.46x5.80 inches; 51,980 stitches
6 thread changes; 6 colors

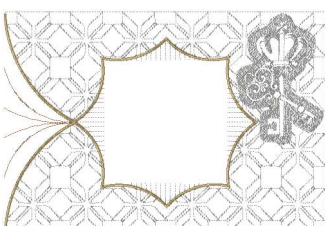

- 1. Golden Lemon (Mar:1003)
- 2. Aqua Sun (Mar:1109)
- 3. Copper (Mar:1137)
- 4. Off White (Mar:1181)
- 5. Cinnamon Sand (Mar:1183)

Design10-10 Inches.pes
9.65x6.61 inches; 24,467 stitches
5 thread changes; 5 colors

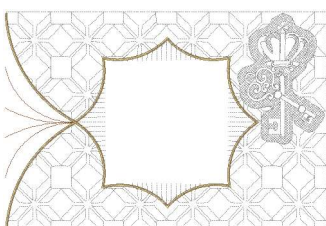

- 1. Golden Lemon (Mar:1003)
- 2. Aqua Sun (Mar:1109)
- 3. Copper (Mar:1137)
- 4. Off White (Mar:1181)
- 5. Cinnamon Sand (Mar:1183)

Design10-12 Inches.pes
11.61x7.96 inches; 27,648 stitches
5 thread changes; 5 colors

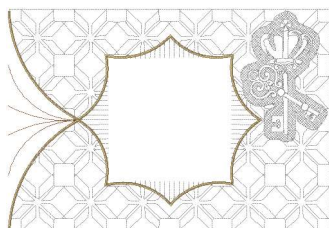

- 1. Golden Lemon (Mar:1003)
- 2. Aqua Sun (Mar:1109)
- 3. Copper (Mar:1137)
- 4. Off White (Mar:1181)
- 5. Cinnamon Sand (Mar:1183)

Design10-13 Inches.pes
12.99x8.91 inches; 30,120 stitches
5 thread changes; 5 colors

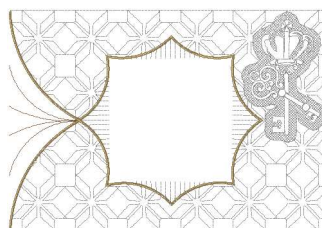

- 1. Golden Lemon (Mar:1003)
- 2. Aqua Sun (Mar:1109)
- 3. Copper (Mar:1137)
- 4. Off White (Mar:1181)
- 5. Cinnamon Sand (Mar:1183)

Design10-14 Inches.pes
15.55x10.66 inches; 35,109 stitches
5 thread changes; 5 colors

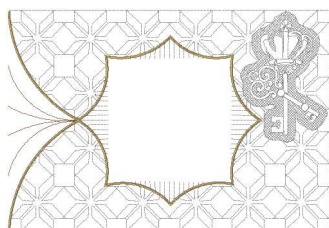

- 1. Golden Lemon (Mar:1003)
- 2. Aqua Sun (Mar:1109)
- 3. Copper (Mar:1137)
- 4. Off White (Mar:1181)
- 5. Cinnamon Sand (Mar:1183)

Design10-16 Inches.pes
15.55x10.66 inches; 35,109 stitches
5 thread changes; 5 colors

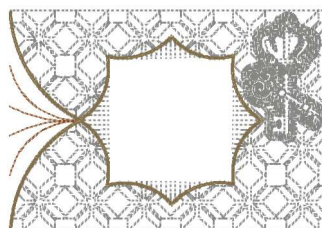

- 1. Golden Lemon (Mar:1003)
- 2. Aqua Sun (Mar:1109)
- 3. Copper (Mar:1137)
- 4. Off White (Mar:1181)
- 5. Cinnamon Sand (Mar:1183)

Design10-5 Inches.pes
4.93x3.38 inches; 15,601 stitches
5 thread changes; 5 colors

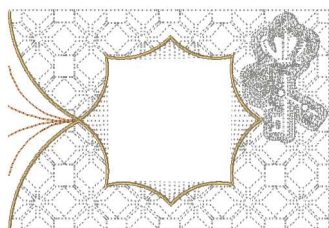

- 1. Golden Lemon (Mar:1003)
- 2. Aqua Sun (Mar:1109)
- 3. Copper (Mar:1137)
- 4. Off White (Mar:1181)
- 5. Cinnamon Sand (Mar:1183)

Design10-6 Inches.pes
5.72x3.91 inches; 17,284 stitches
5 thread changes; 5 colors

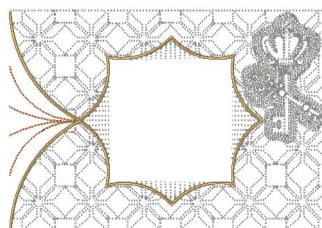

- 1. Golden Lemon (Mar:1003)
- 2. Aqua Sun (Mar:1109)
- 3. Copper (Mar:1137)
- 4. Off White (Mar:1181)
- 5. Cinnamon Sand (Mar:1183)

Design10-8 Inches.pes
7.69x5.27 inches; 20,982 stitches
5 thread changes; 5 colors

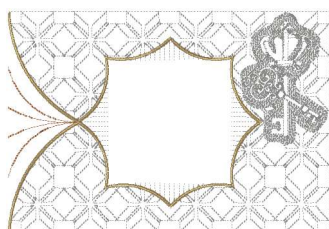

- 1. Golden Lemon (Mar:1003)
- 2. Aqua Sun (Mar:1109)
- 3. Copper (Mar:1137)
- 4. Off White (Mar:1181)
- 5. Cinnamon Sand (Mar:1183)

Design10-9 Inches.pes
8.46x5.80 inches; 21,985 stitches
5 thread changes; 5 colors

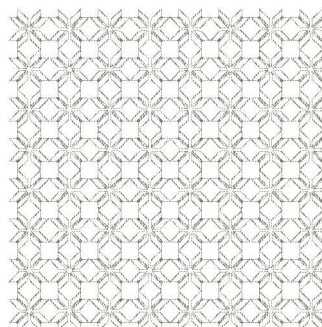

- 1. Sage Cream (Mar:1182)

Design2-10 Inch.pes
9.65x9.65 inches; 25,125 stitches
1 thread changes; 1 colors

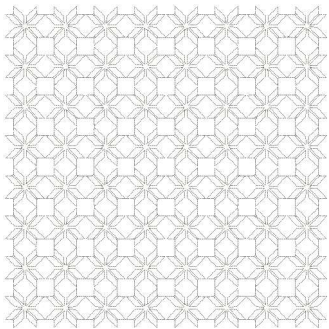

■ 1. Sage Cream (Mar:1182)

Design2-12 Inch.pes
11.61x11.61 inches; 28,712 stitches
1 thread changes; 1 colors

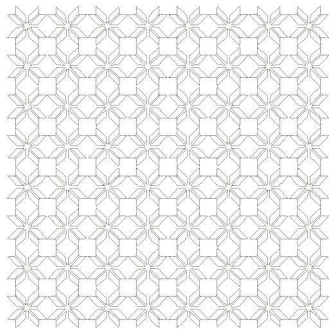

■ 1. Sage Cream (Mar:1182)

Design2-13 Inch.pes
12.99x12.99 inches; 31,269 stitches
1 thread changes; 1 colors

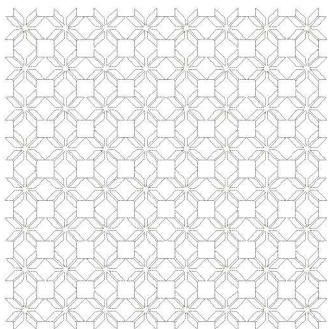

■ 1. Sage Cream (Mar:1182)

Design2-14 Inch.pes
13.58x13.58 inches; 32,557 stitches
1 thread changes; 1 colors

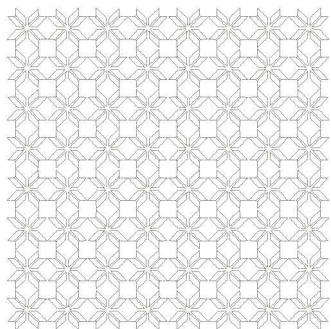

■ 1. Sage Cream (Mar:1182)

Design2-16 Inch.pes
15.55x15.55 inches; 35,882 stitches
1 thread changes; 1 colors

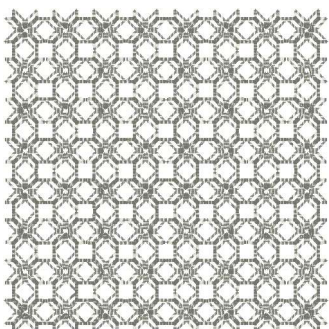

■ 1. Sage Cream (Mar:1182)

Design2-4 Inch.pes
3.74x3.74 inches; 16,433 stitches
1 thread changes; 1 colors

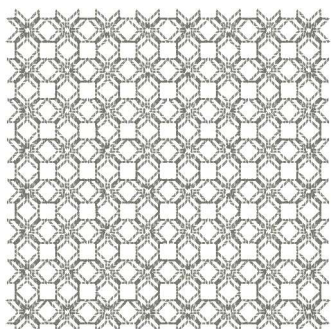

■ 1. Sage Cream (Mar:1182)

Design2-5 Inch.pes
4.92x4.92 inches; 17,464 stitches
1 thread changes; 1 colors

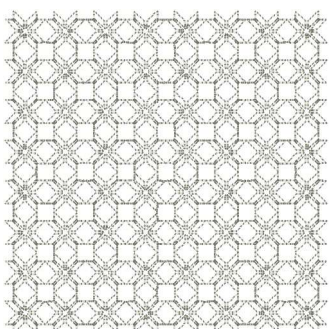

■ 1. Sage Cream (Mar:1182)

Design2-6 Inch.pes
5.71x5.71 inches; 19,000 stitches
1 thread changes; 1 colors

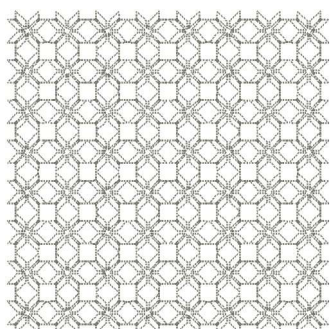

■ 1. Sage Cream (Mar:1182)

Design2-8 Inch.pes
7.68x7.68 inches; 22,571 stitches
1 thread changes; 1 colors

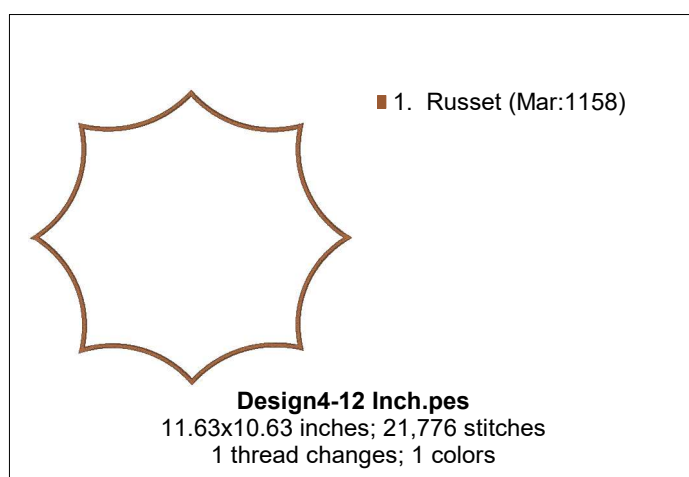
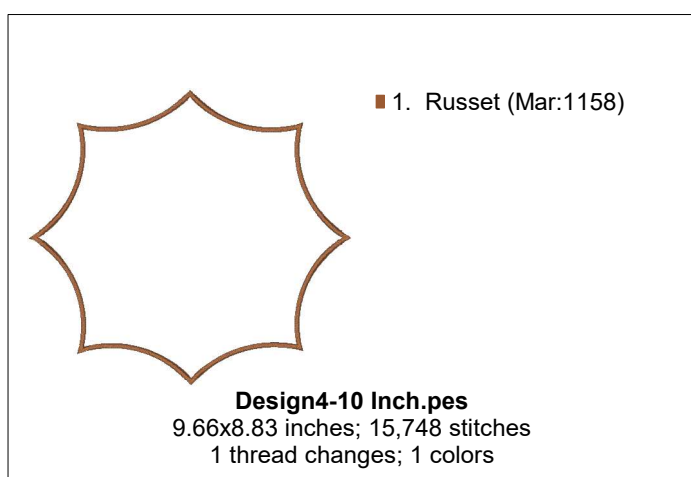
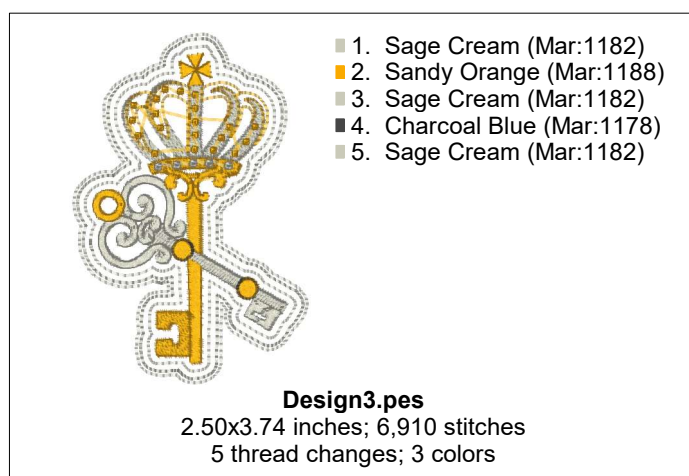
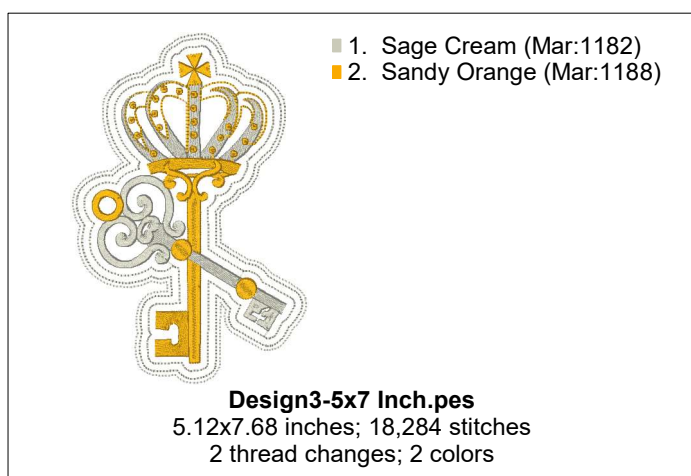
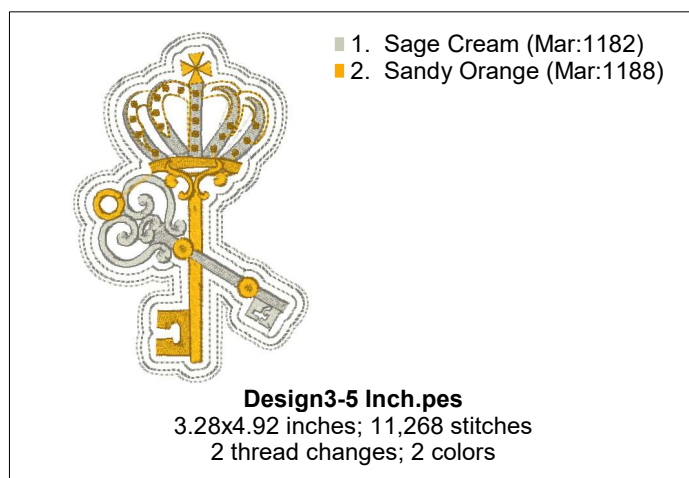
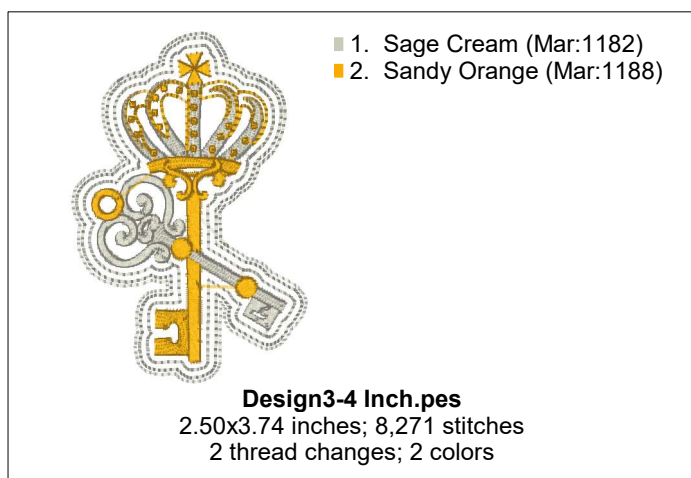
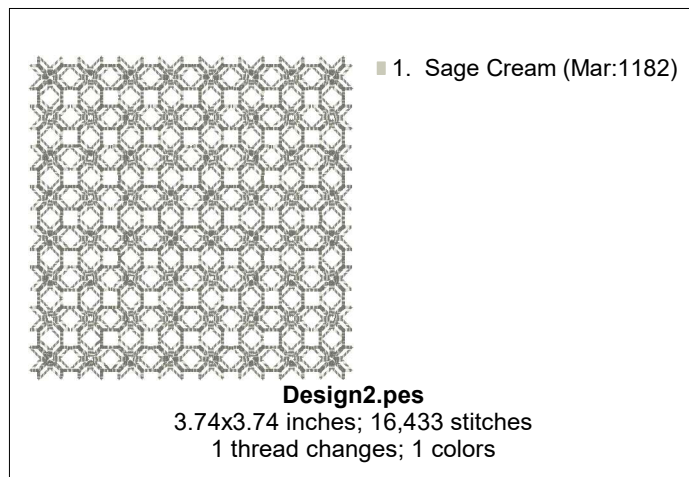
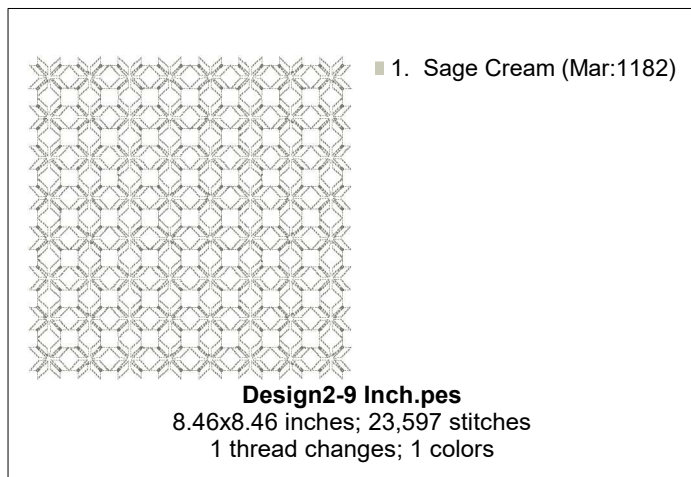

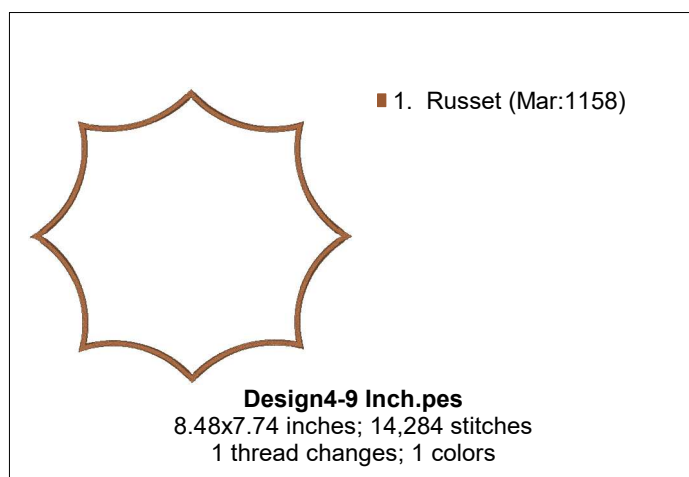
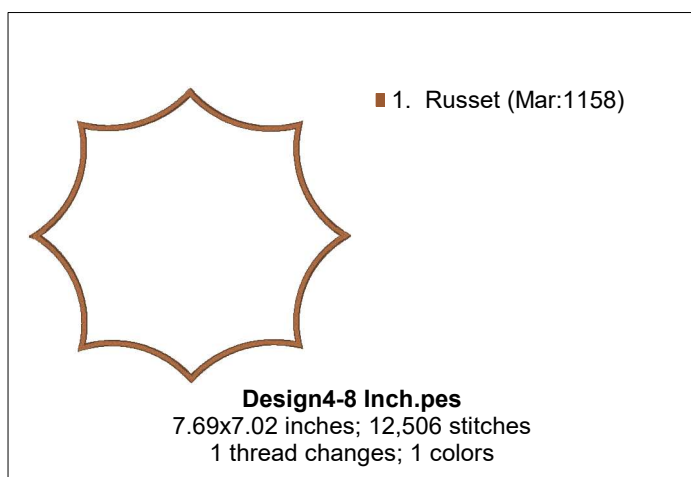
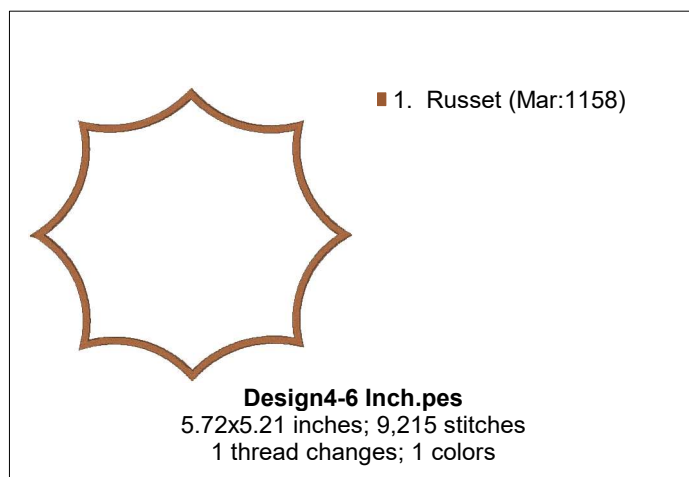
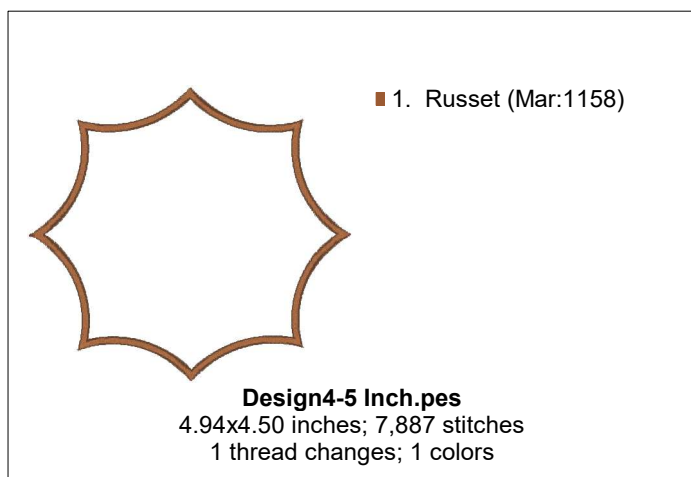
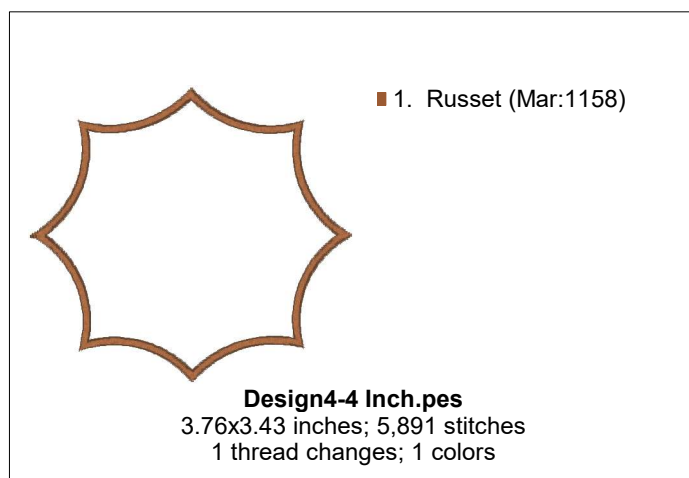
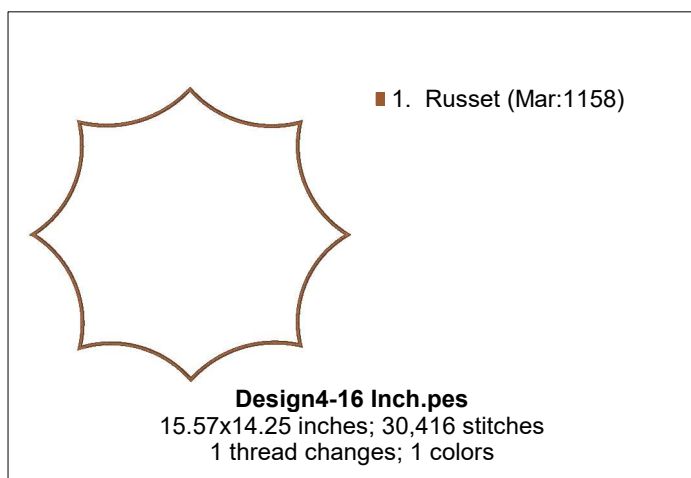
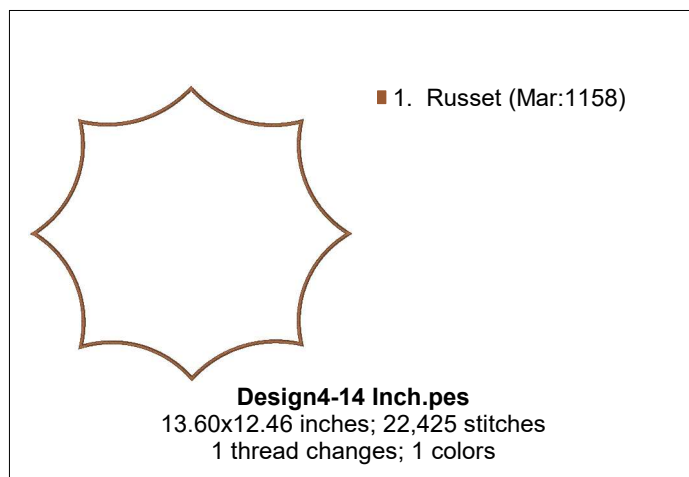
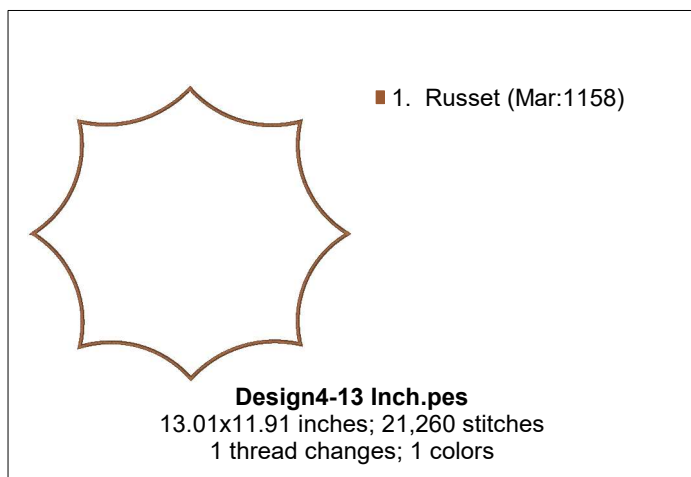

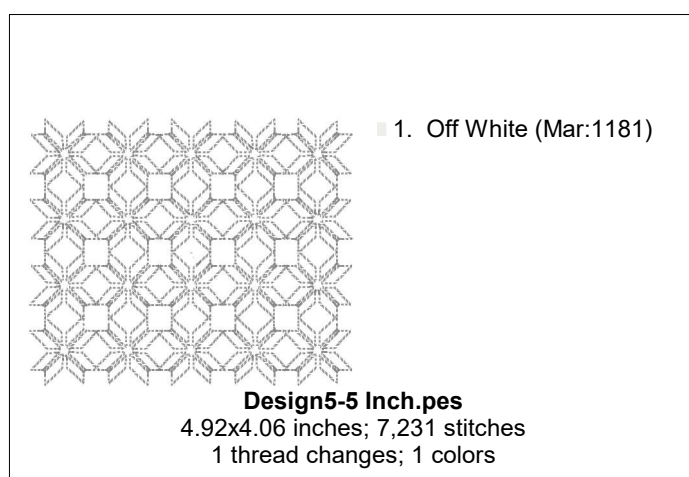
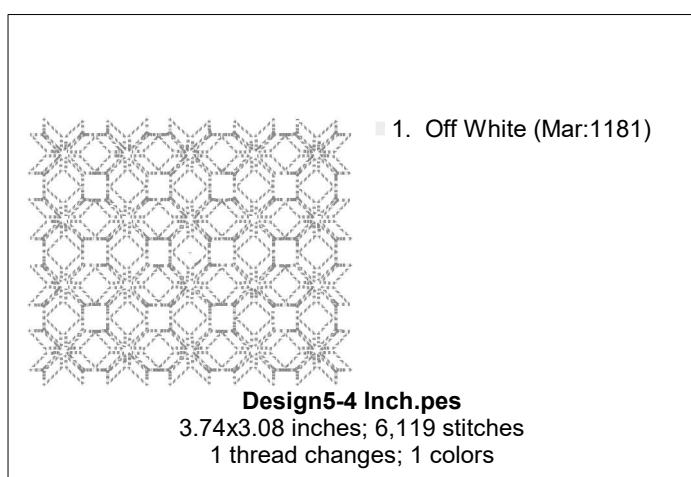
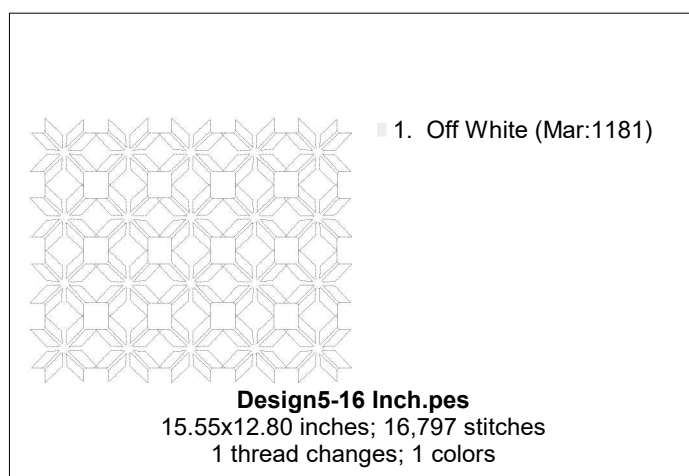
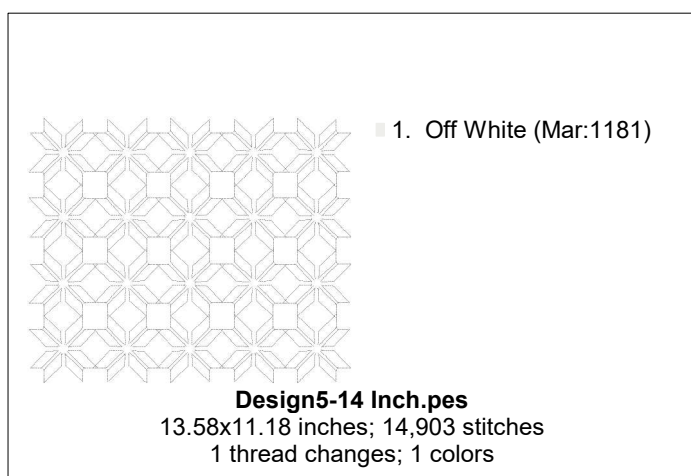
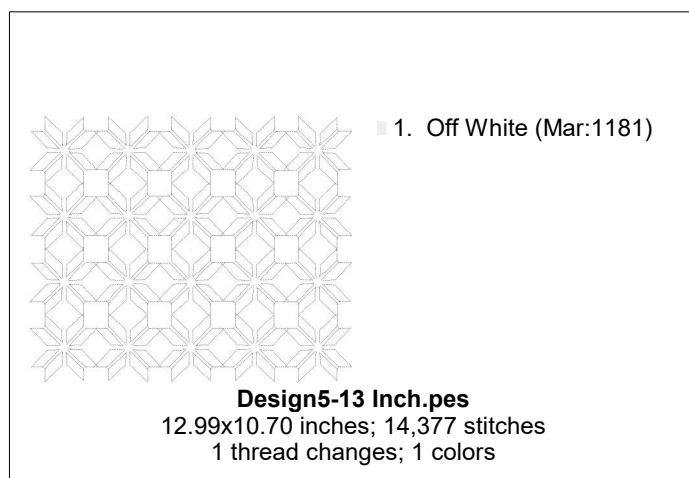
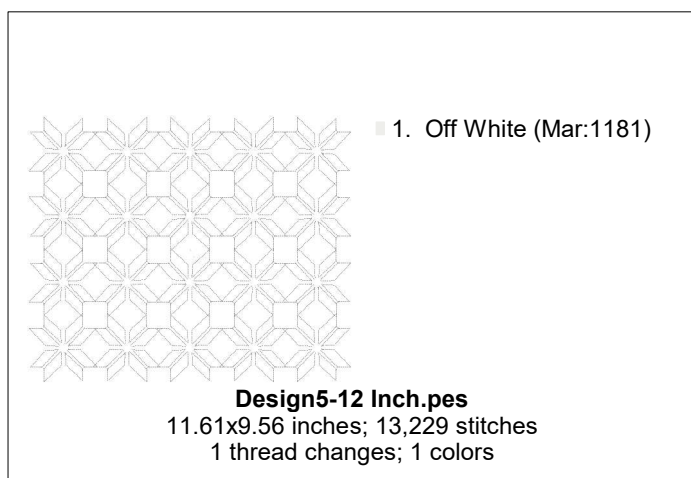
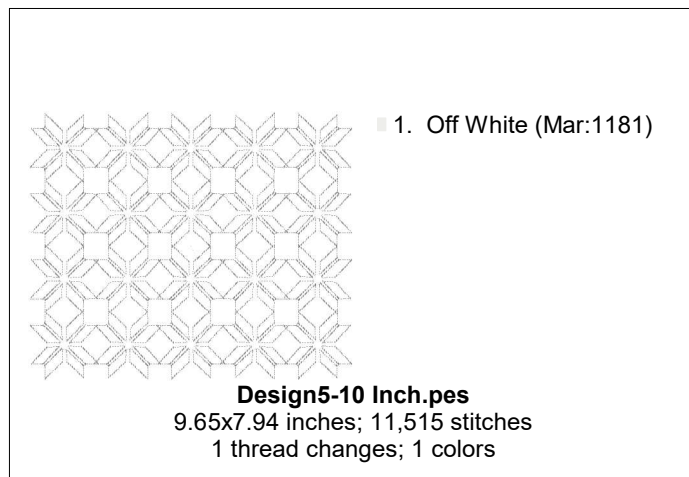
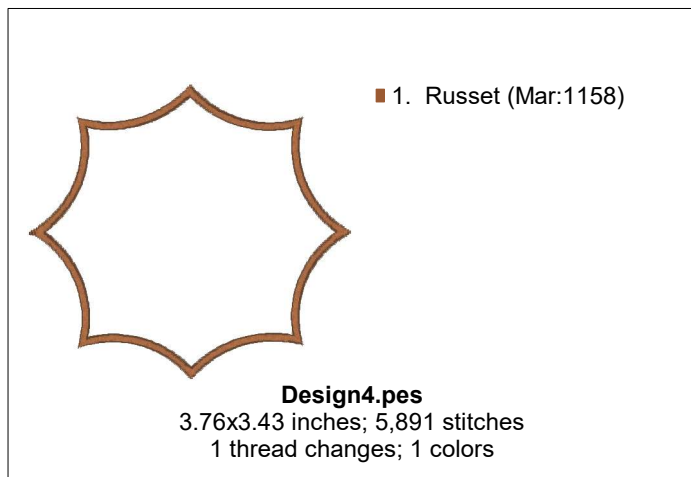

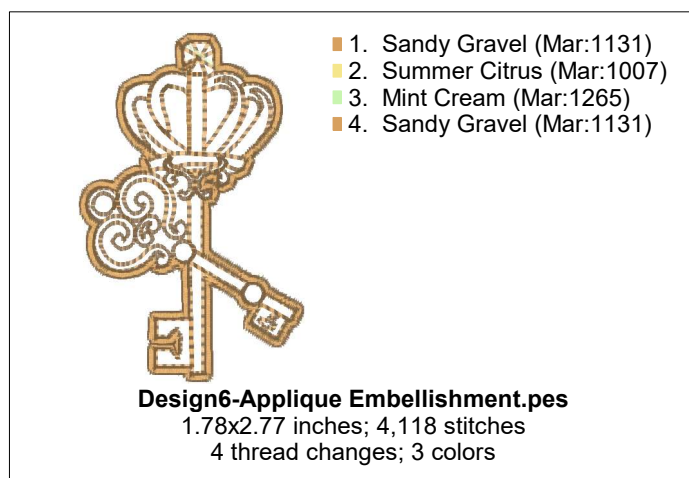
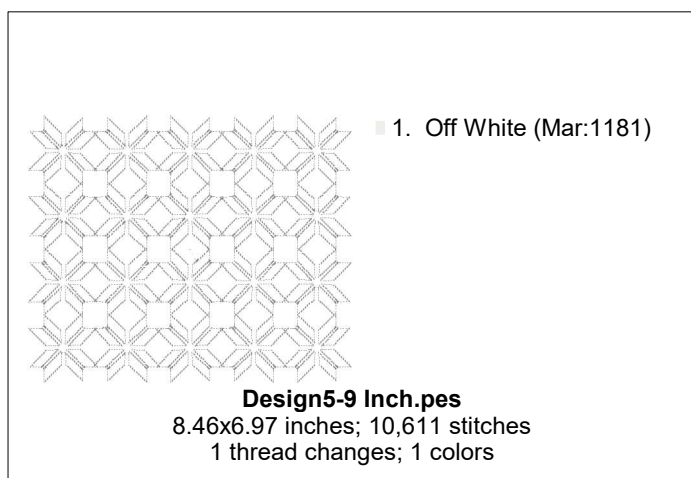
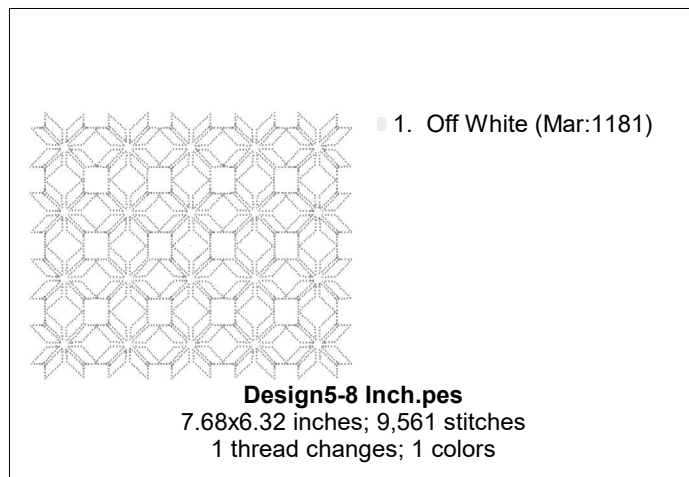
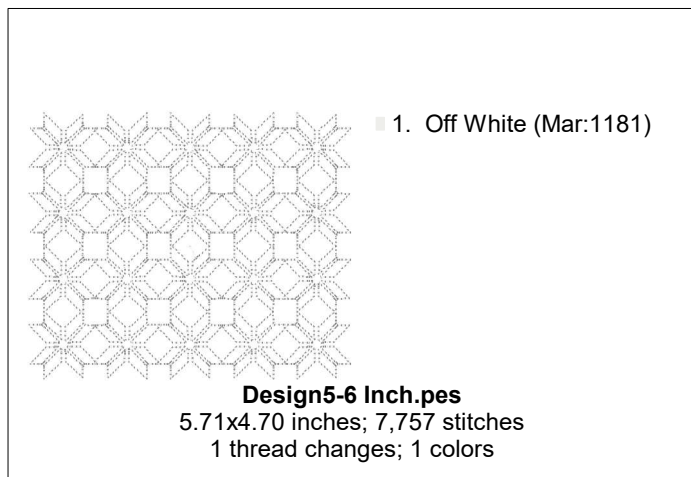

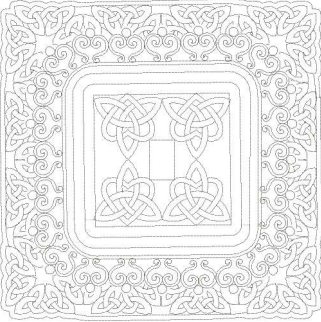

■ 1. Sage Cream (Mar:1182)

Design7-16 Inch.pes
15.55x15.55 inches; 38,804 stitches
1 thread changes; 1 colors



■ 1. Sage Cream (Mar:1182)

Design7-4 Inch.pes
3.74x3.74 inches; 16,793 stitches
1 thread changes; 1 colors

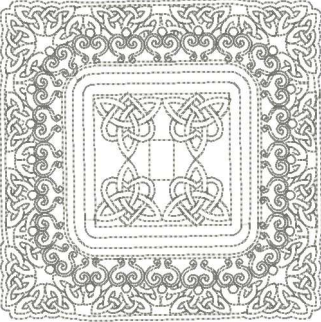

■ 1. Sage Cream (Mar:1182)

Design7-5 Inch.pes
4.92x4.92 inches; 19,347 stitches
1 thread changes; 1 colors



■ 1. Sage Cream (Mar:1182)

Design7-6 Inch.pes
5.71x5.71 inches; 20,574 stitches
1 thread changes; 1 colors



■ 1. Sage Cream (Mar:1182)

Design7-8 Inch.pes
7.68x7.68 inches; 24,833 stitches
1 thread changes; 1 colors



■ 1. Sage Cream (Mar:1182)

Design7-9 Inch.pes
8.46x8.46 inches; 25,130 stitches
1 thread changes; 1 colors

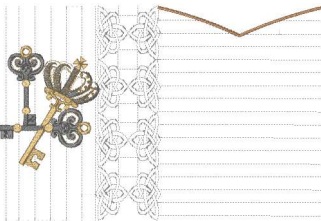

■ 1. Golden Lemon (Mar:1003)
■ 2. Pale Lawn (Mar:1119)
■ 3. Off White (Mar:1181)
■ 4. Leaden Gray (Mar:1320)
■ 5. Cinnamon Sand (Mar:1183)
■ 6. Copper (Mar:1137)

Design8-10 Inch.pes
9.65x6.42 inches; 20,579 stitches
6 thread changes; 6 colors

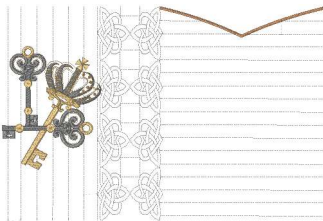

■ 1. Golden Lemon (Mar:1003)
■ 2. Pale Lawn (Mar:1119)
■ 3. Off White (Mar:1181)
■ 4. Leaden Gray (Mar:1320)
■ 5. Cinnamon Sand (Mar:1183)
■ 6. Copper (Mar:1137)

Design8-12 Inch.pes
11.61x7.72 inches; 24,347 stitches
6 thread changes; 6 colors

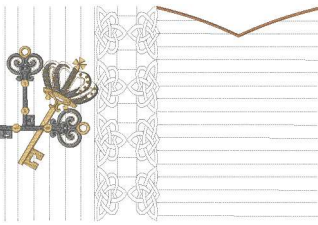

- 1. Golden Lemon (Mar:1003)
- 2. Pale Lawn (Mar:1119)
- 3. Off White (Mar:1181)
- 4. Leaden Gray (Mar:1320)
- 5. Cinnamon Sand (Mar:1183)
- 6. Copper (Mar:1137)

Design8-13 Inch.pes
 12.99x8.64 inches; 26,833 stitches
 6 thread changes; 6 colors

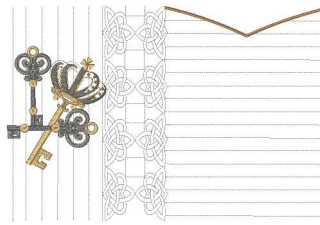

- 1. Golden Lemon (Mar:1003)
- 2. Pale Lawn (Mar:1119)
- 3. Off White (Mar:1181)
- 4. Leaden Gray (Mar:1320)
- 5. Cinnamon Sand (Mar:1183)
- 6. Copper (Mar:1137)

Design8-14 Inch.pes
 13.58x9.03 inches; 27,987 stitches
 6 thread changes; 6 colors

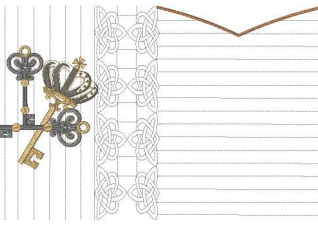

- 1. Golden Lemon (Mar:1003)
- 2. Pale Lawn (Mar:1119)
- 3. Off White (Mar:1181)
- 4. Leaden Gray (Mar:1320)
- 5. Cinnamon Sand (Mar:1183)
- 6. Copper (Mar:1137)

Design8-16 Inch.pes
 15.55x10.34 inches; 32,125 stitches
 6 thread changes; 6 colors

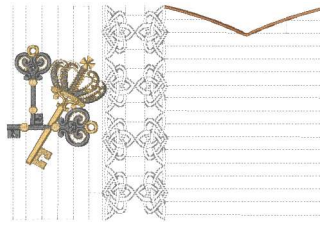

- 1. Golden Lemon (Mar:1003)
- 2. Pale Lawn (Mar:1119)
- 3. Off White (Mar:1181)
- 4. Leaden Gray (Mar:1320)
- 5. Cinnamon Sand (Mar:1183)
- 6. Copper (Mar:1137)

Design8-9 Inch.pes
 8.46x5.63 inches; 18,418 stitches
 6 thread changes; 6 colors

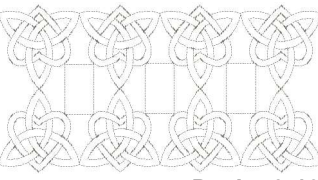

- 1. Sage Cream (Mar:1182)

Design9-10 Inches.pes
 9.65x4.98 inches; 6,788 stitches
 1 thread changes; 1 colors

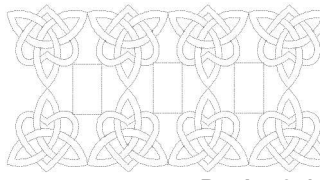

- 1. Sage Cream (Mar:1182)

Design9-12 Inches.pes
 11.61x6.00 inches; 7,647 stitches
 1 thread changes; 1 colors

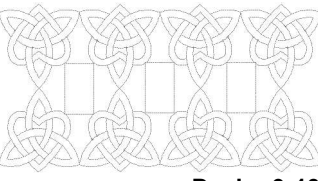

- 1. Sage Cream (Mar:1182)

Design9-13 Inches.pes
 12.99x6.71 inches; 8,569 stitches
 1 thread changes; 1 colors

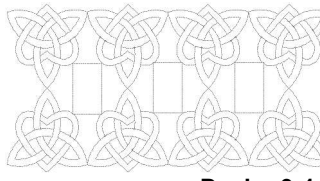

- 1. Sage Cream (Mar:1182)

Design9-14 Inches.pes
 13.58x7.02 inches; 8,943 stitches
 1 thread changes; 1 colors

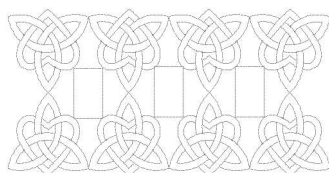

■ 1. Sage Cream (Mar:1182)

Design9-16 Inches.pes
15.55x8.03 inches; 10,319 stitches
1 thread changes; 1 colors

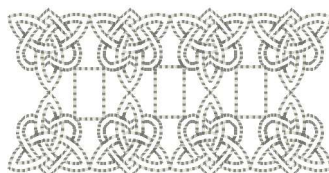

■ 1. Sage Cream (Mar:1182)

Design9-4 Inches.pes
3.74x1.93 inches; 3,909 stitches
1 thread changes; 1 colors

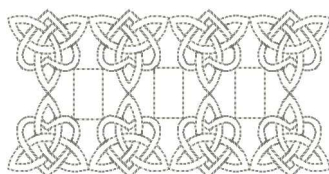

■ 1. Sage Cream (Mar:1182)

Design9-5 Inches.pes
4.92x2.54 inches; 4,364 stitches
1 thread changes; 1 colors

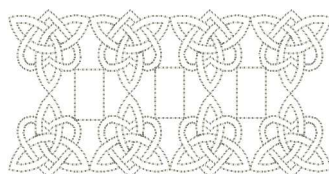

■ 1. Sage Cream (Mar:1182)

Design9-6 Inches.pes
5.71x2.94 inches; 4,396 stitches
1 thread changes; 1 colors

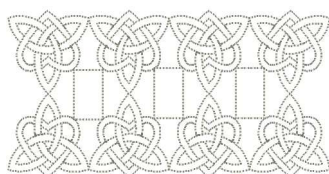

■ 1. Sage Cream (Mar:1182)

Design9-8 Inches.pes
7.68x3.96 inches; 5,716 stitches
1 thread changes; 1 colors

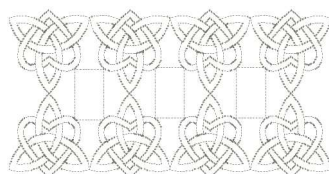

■ 1. Sage Cream (Mar:1182)

Design9-9 Inches.pes
8.46x4.37 inches; 6,230 stitches
1 thread changes; 1 colors