

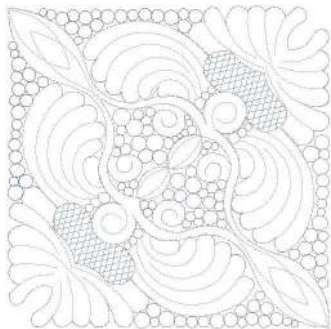

■ 1. Off White (Mar:1181)
■ 2. Glacier Blue (Mar:1094)
■ 3. Off White (Mar:1181)

Design1-10x10.pes
9.65x9.65 inches; 23,581 stitches
3 thread changes; 2 colors



■ 1. Off White (Mar:1181)
■ 2. Glacier Blue (Mar:1094)
■ 3. Off White (Mar:1181)

Design1-12x12.pes
11.61x11.61 inches; 26,924 stitches
3 thread changes; 2 colors

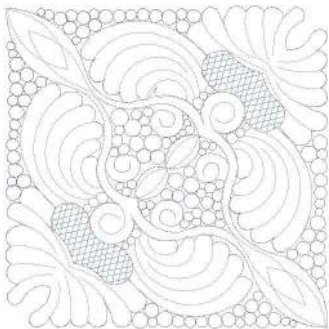

■ 1. Dusky Pink (Mar:1021)
■ 2. Glacier Blue (Mar:1094)
■ 3. Off White (Mar:1181)

Design1-13x13.pes
12.99x12.99 inches; 29,138 stitches
3 thread changes; 3 colors

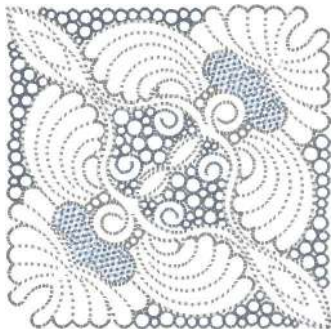

■ 1. Off White (Mar:1181)
■ 2. Glacier Blue (Mar:1094)
■ 3. Off White (Mar:1181)

Design1-4x4.pes
3.74x3.74 inches; 12,210 stitches
3 thread changes; 2 colors



■ 1. Off White (Mar:1181)
■ 2. Glacier Blue (Mar:1094)
■ 3. Off White (Mar:1181)

Design1-5x5.pes
4.92x4.92 inches; 14,862 stitches
3 thread changes; 2 colors



■ 1. Off White (Mar:1181)
■ 2. Glacier Blue (Mar:1094)
■ 3. Off White (Mar:1181)

Design1-5x7.pes
7.68x3.83 inches; 24,090 stitches
3 thread changes; 2 colors



■ 1. Off White (Mar:1181)
■ 2. Glacier Blue (Mar:1094)
■ 3. Off White (Mar:1181)

Design1-6x10.pes
9.65x4.82 inches; 28,407 stitches
3 thread changes; 2 colors

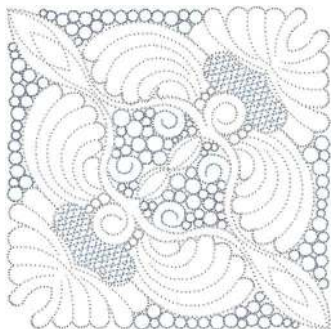

■ 1. Off White (Mar:1181)
■ 2. Glacier Blue (Mar:1094)
■ 3. Off White (Mar:1181)

Design1-6x6.pes
5.71x5.71 inches; 16,506 stitches
3 thread changes; 2 colors

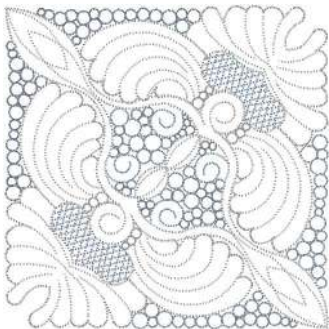

■ 1. Off White (Mar:1181)
■ 2. Glacier Blue (Mar:1094)
■ 3. Off White (Mar:1181)

Design1-8x8.pes
7.68x7.68 inches; 20,230 stitches
3 thread changes; 2 colors

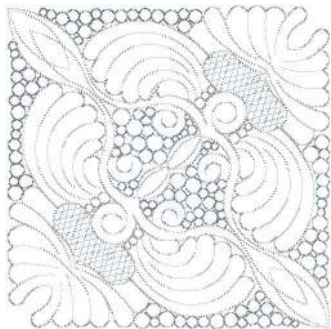

■ 1. Off White (Mar:1181)
■ 2. Glacier Blue (Mar:1094)
■ 3. Off White (Mar:1181)

Design1-9x9.pes
8.46x8.46 inches; 21,675 stitches
3 thread changes; 2 colors

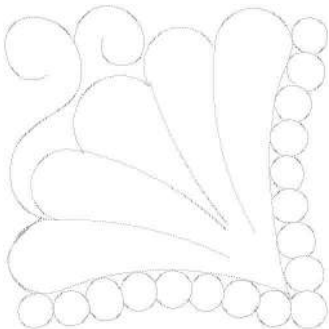

■ 1. Off White (Mar:1181)
■ 2. Glacier Blue (Mar:1094)
■ 3. Off White (Mar:1181)

Design10-10x10.pes
9.65x9.65 inches; 4,199 stitches
3 thread changes; 2 colors

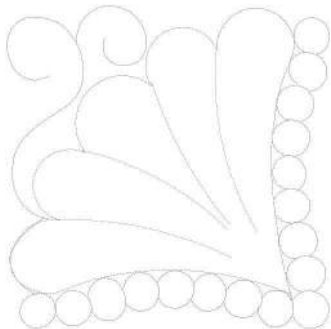

■ 1. Off White (Mar:1181)
■ 2. Glacier Blue (Mar:1094)
■ 3. Off White (Mar:1181)

Design10-12x12.pes
11.61x11.61 inches; 4,985 stitches
3 thread changes; 2 colors

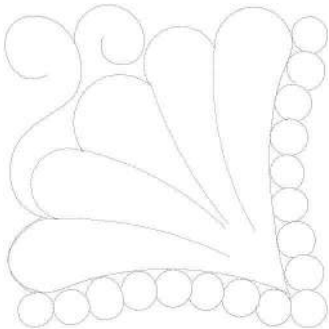

■ 1. Off White (Mar:1181)
■ 2. Glacier Blue (Mar:1094)
■ 3. Off White (Mar:1181)

Design10-13x13.pes
12.99x12.99 inches; 5,555 stitches
3 thread changes; 2 colors

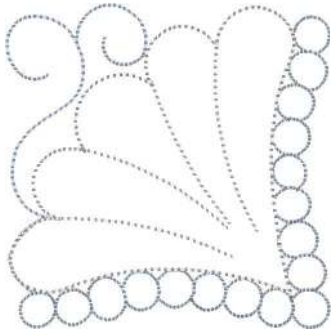

■ 1. Off White (Mar:1181)
■ 2. Glacier Blue (Mar:1094)
■ 3. Off White (Mar:1181)

Design10-4x4.pes
3.74x3.74 inches; 2,042 stitches
3 thread changes; 2 colors

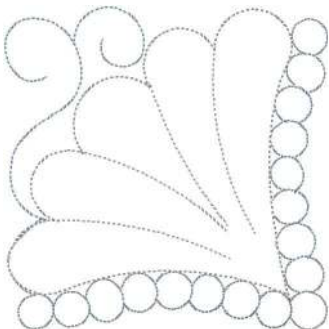

■ 1. Off White (Mar:1181)
■ 2. Glacier Blue (Mar:1094)
■ 3. Off White (Mar:1181)

Design10-5x5.pes
4.92x4.92 inches; 2,469 stitches
3 thread changes; 2 colors

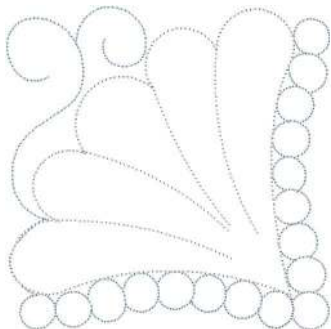

■ 1. Off White (Mar:1181)
■ 2. Glacier Blue (Mar:1094)
■ 3. Off White (Mar:1181)

Design10-6x6.pes
5.71x5.71 inches; 2,744 stitches
3 thread changes; 2 colors

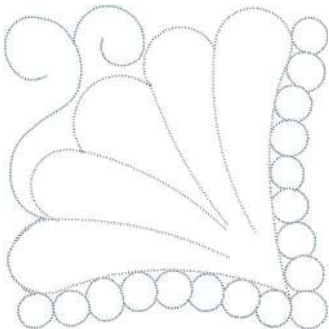

■ 1. Off White (Mar:1181)
 ■ 2. Glacier Blue (Mar:1094)
 ■ 3. Off White (Mar:1181)

Design10-8x8.pes
 7.68x7.68 inches; 3,444 stitches
 3 thread changes; 2 colors

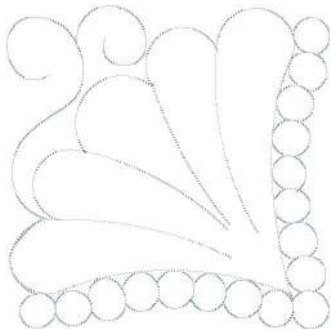

■ 1. Off White (Mar:1181)
 ■ 2. Glacier Blue (Mar:1094)
 ■ 3. Off White (Mar:1181)

Design10-9x9.pes
 8.46x8.46 inches; 3,733 stitches
 3 thread changes; 2 colors

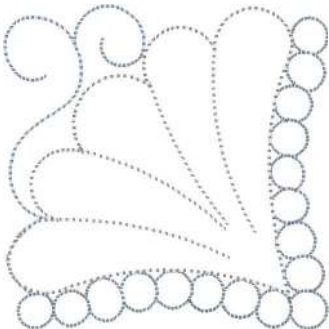

■ 1. Off White (Mar:1181)
 ■ 2. Glacier Blue (Mar:1094)
 ■ 3. Off White (Mar:1181)

Design10-Cornerblock-4x4.pes
 3.74x3.74 inches; 2,044 stitches
 3 thread changes; 2 colors

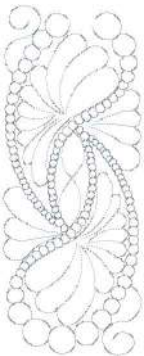

■ 1. Off White (Mar:1181)
 ■ 2. Glacier Blue (Mar:1094)
 ■ 3. Off White (Mar:1181)

Design11-Border-10x10.pes
 3.79x9.65 inches; 7,607 stitches
 3 thread changes; 2 colors



■ 1. Off White (Mar:1181)
 ■ 2. Glacier Blue (Mar:1094)
 ■ 3. Off White (Mar:1181)

Design11-Border-12x12.pes
 4.57x11.61 inches; 8,481 stitches
 3 thread changes; 2 colors



■ 1. Off White (Mar:1181)
 ■ 2. Glacier Blue (Mar:1094)
 ■ 3. Off White (Mar:1181)

Design11-Border-13x13.pes
 5.11x12.99 inches; 9,103 stitches
 3 thread changes; 2 colors

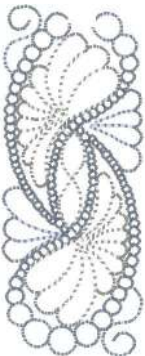

■ 1. Off White (Mar:1181)
 ■ 2. Glacier Blue (Mar:1094)
 ■ 3. Off White (Mar:1181)

Design11-Border-4x4.pes
 1.47x3.74 inches; 3,901 stitches
 3 thread changes; 2 colors



■ 1. Off White (Mar:1181)
 ■ 2. Glacier Blue (Mar:1094)
 ■ 3. Off White (Mar:1181)

Design11-Border-5x5.pes
 1.93x4.92 inches; 4,780 stitches
 3 thread changes; 2 colors

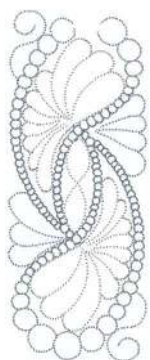

- 1. Off White (Mar:1181)
- 2. Glacier Blue (Mar:1094)
- 3. Off White (Mar:1181)

Design11-Border-5x7.pes
3.02x7.68 inches; 6,508 stitches
3 thread changes; 2 colors



- 1. Off White (Mar:1181)
- 2. Glacier Blue (Mar:1094)
- 3. Off White (Mar:1181)

Design11-Border-5x7b.pes
1.50x7.68 inches; 8,587 stitches
3 thread changes; 2 colors



- 1. Off White (Mar:1181)
- 2. Glacier Blue (Mar:1094)
- 3. Off White (Mar:1181)

Design11-Border-6x10.pes
3.79x9.65 inches; 7,557 stitches
3 thread changes; 2 colors



- 1. Off White (Mar:1181)
- 2. Glacier Blue (Mar:1094)
- 3. Off White (Mar:1181)

Design11-Border-6x10b.pes
1.89x9.65 inches; 10,030 stitches
3 thread changes; 2 colors

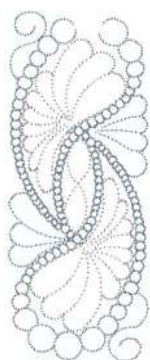

- 1. Off White (Mar:1181)
- 2. Glacier Blue (Mar:1094)
- 3. Off White (Mar:1181)

Design11-Border-6x6.pes
2.24x5.71 inches; 5,301 stitches
3 thread changes; 2 colors



- 1. Off White (Mar:1181)
- 2. Glacier Blue (Mar:1094)
- 3. Off White (Mar:1181)

Design11-Border-8x8.pes
3.02x7.68 inches; 6,529 stitches
3 thread changes; 2 colors

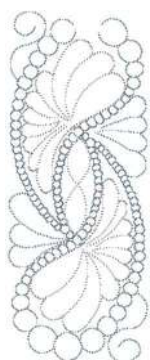

- 1. Off White (Mar:1181)
- 2. Glacier Blue (Mar:1094)
- 3. Off White (Mar:1181)

Design11-Border-9x9.pes
3.33x8.46 inches; 6,977 stitches
3 thread changes; 2 colors

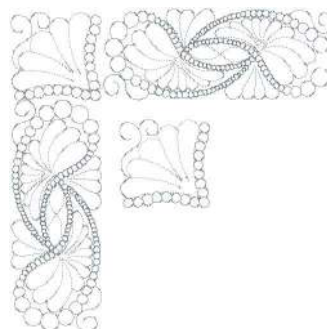

- 1. Off White (Mar:1181)
- 2. Glacier Blue (Mar:1094)
- 3. Off White (Mar:1181)

Design12-Corner-10x10.pes
9.65x9.65 inches; 15,607 stitches
3 thread changes; 2 colors

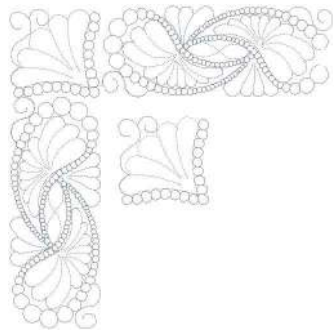

- 1. Off White (Mar:1181)
- 2. Glacier Blue (Mar:1094)
- 3. Off White (Mar:1181)

Design12-Corner-12x12.pes
11.61x11.61 inches; 17,735 stitches
3 thread changes; 2 colors

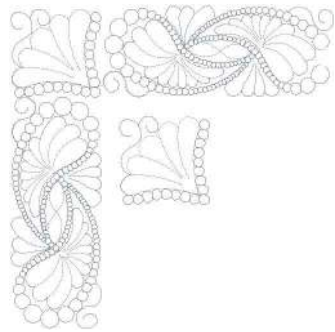

- 1. Off White (Mar:1181)
- 2. Glacier Blue (Mar:1094)
- 3. Off White (Mar:1181)

Design12-Corner-13x13.pes
12.99x12.99 inches; 19,192 stitches
3 thread changes; 2 colors



- 1. Off White (Mar:1181)
- 2. Glacier Blue (Mar:1094)
- 3. Off White (Mar:1181)

Design12-Corner-4x4.pes
3.74x3.74 inches; 7,870 stitches
3 thread changes; 2 colors



- 1. Off White (Mar:1181)
- 2. Glacier Blue (Mar:1094)
- 3. Off White (Mar:1181)

Design12-Corner-5x5.pes
4.92x4.92 inches; 9,798 stitches
3 thread changes; 2 colors



- 1. Off White (Mar:1181)
- 2. Glacier Blue (Mar:1094)
- 3. Off White (Mar:1181)

Design12-Corner-5x7.pes
7.68x3.83 inches; 16,232 stitches
3 thread changes; 2 colors



- 1. Off White (Mar:1181)
- 2. Glacier Blue (Mar:1094)
- 3. Off White (Mar:1181)

Design12-Corner-6x10.pes
9.65x4.82 inches; 19,417 stitches
3 thread changes; 2 colors



- 1. Off White (Mar:1181)
- 2. Glacier Blue (Mar:1094)
- 3. Off White (Mar:1181)

Design12-Corner-6x6.pes
5.71x5.71 inches; 10,911 stitches
3 thread changes; 2 colors



- 1. Off White (Mar:1181)
- 2. Glacier Blue (Mar:1094)
- 3. Off White (Mar:1181)

Design12-Corner-8x8.pes
7.68x7.68 inches; 13,338 stitches
3 thread changes; 2 colors



■ 1. Off White (Mar:1181)
■ 2. Glacier Blue (Mar:1094)
■ 3. Off White (Mar:1181)

Design12-Corner-9x9.pes
8.46x8.46 inches; 14,274 stitches
3 thread changes; 2 colors

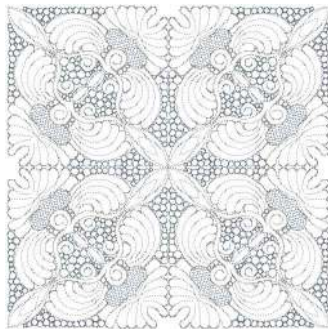

■ 1. Off White (Mar:1181)
■ 2. Glacier Blue (Mar:1094)
■ 3. Off White (Mar:1181)

Design2-10x10.pes
9.65x9.65 inches; 56,669 stitches
3 thread changes; 2 colors

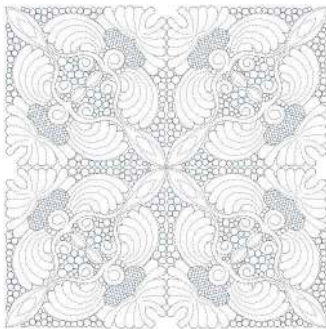

■ 1. Off White (Mar:1181)
■ 2. Glacier Blue (Mar:1094)
■ 3. Off White (Mar:1181)

Design2-12x12.pes
11.61x11.61 inches; 64,174 stitches
3 thread changes; 2 colors

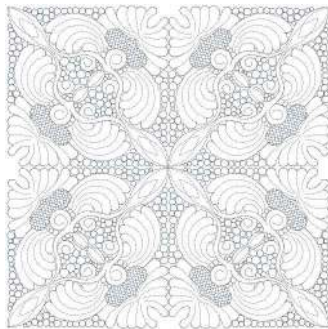

■ 1. Off White (Mar:1181)
■ 2. Glacier Blue (Mar:1094)
■ 3. Off White (Mar:1181)

Design2-13x13.pes
12.99x12.99 inches; 69,133 stitches
3 thread changes; 2 colors

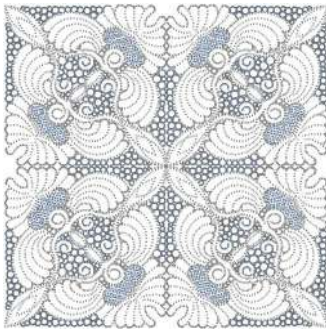

■ 1. Off White (Mar:1181)
■ 2. Glacier Blue (Mar:1094)
■ 3. Off White (Mar:1181)

Design2-8x8.pes
7.68x7.68 inches; 48,066 stitches
3 thread changes; 2 colors

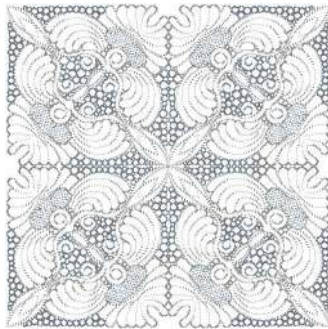

■ 1. Off White (Mar:1181)
■ 2. Glacier Blue (Mar:1094)
■ 3. Off White (Mar:1181)

Design2-9x9.pes
8.46x8.46 inches; 51,689 stitches
3 thread changes; 2 colors



■ 1. Off White (Mar:1181)
■ 2. Glacier Blue (Mar:1094)
■ 3. Off White (Mar:1181)

Design3-10x10.pes
9.65x9.65 inches; 15,846 stitches
3 thread changes; 2 colors



■ 1. Off White (Mar:1181)
■ 2. Glacier Blue (Mar:1094)
■ 3. Off White (Mar:1181)

Design3-12x12.pes
11.61x11.61 inches; 18,427 stitches
3 thread changes; 2 colors

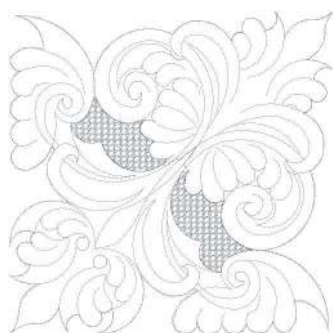

- 1. Off White (Mar:1181)
- 2. Glacier Blue (Mar:1094)
- 3. Off White (Mar:1181)

Design3-13x13.pes

12.99x12.99 inches; 20,216 stitches
3 thread changes; 2 colors



- 1. Off White (Mar:1181)
- 2. Glacier Blue (Mar:1094)
- 3. Off White (Mar:1181)

Design3-4x4.pes

3.74x3.74 inches; 8,826 stitches
3 thread changes; 2 colors



- 1. Off White (Mar:1181)
- 2. Glacier Blue (Mar:1094)
- 3. Off White (Mar:1181)

Design3-5x5.pes

4.92x4.92 inches; 10,287 stitches
3 thread changes; 2 colors

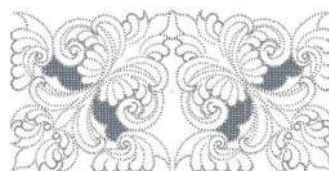

- 1. Off White (Mar:1181)
- 2. Glacier Blue (Mar:1094)
- 3. Off White (Mar:1181)

Design3-5x7.pes

7.68x3.83 inches; 17,880 stitches
3 thread changes; 2 colors



- 1. Off White (Mar:1181)
- 2. Glacier Blue (Mar:1094)
- 3. Off White (Mar:1181)

Design3-6x10.pes

9.65x4.83 inches; 20,118 stitches
3 thread changes; 2 colors

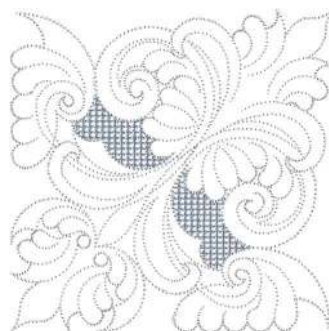

- 1. Off White (Mar:1181)
- 2. Glacier Blue (Mar:1094)
- 3. Off White (Mar:1181)

Design3-6x6.pes

5.71x5.71 inches; 10,965 stitches
3 thread changes; 2 colors

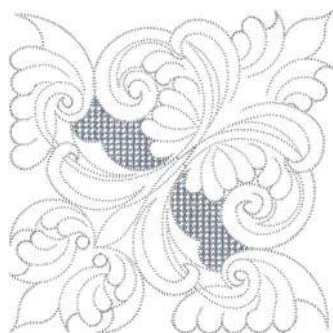

- 1. Off White (Mar:1181)
- 2. Glacier Blue (Mar:1094)
- 3. Off White (Mar:1181)

Design3-8x8.pes

7.68x7.68 inches; 13,566 stitches
3 thread changes; 2 colors

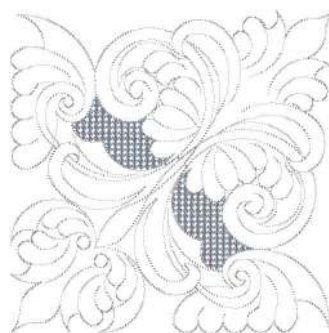

- 1. Off White (Mar:1181)
- 2. Glacier Blue (Mar:1094)
- 3. Off White (Mar:1181)

Design3-9x9.pes

8.46x8.46 inches; 14,571 stitches
3 thread changes; 2 colors



- 1. Off White (Mar:1181)
- 2. Glacier Blue (Mar:1094)
- 3. Off White (Mar:1181)

Design4-10x10.pes
 9.65x9.65 inches; 41,648 stitches
 3 thread changes; 2 colors



- 1. Off White (Mar:1181)
- 2. Glacier Blue (Mar:1094)
- 3. Off White (Mar:1181)

Design4-12x12.pes
 11.61x11.61 inches; 45,115 stitches
 3 thread changes; 2 colors



- 1. Off White (Mar:1181)
- 2. Glacier Blue (Mar:1094)
- 3. Off White (Mar:1181)

Design4-13x13.pes
 12.99x12.99 inches; 48,358 stitches
 3 thread changes; 2 colors



- 1. Off White (Mar:1181)
- 2. Glacier Blue (Mar:1094)
- 3. Off White (Mar:1181)

Design4-8x8.pes
 7.68x7.68 inches; 36,539 stitches
 3 thread changes; 2 colors



- 1. Off White (Mar:1181)
- 2. Glacier Blue (Mar:1094)
- 3. Off White (Mar:1181)

Design4-9x9.pes
 8.46x8.46 inches; 38,343 stitches
 3 thread changes; 2 colors

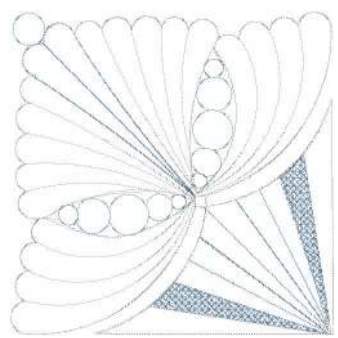

- 1. Off White (Mar:1181)
- 2. Blue - Med. (Hat:201)
- 3. Off White (Mar:1181)

Design5-10x10.pes
 9.65x9.65 inches; 13,893 stitches
 3 thread changes; 2 colors

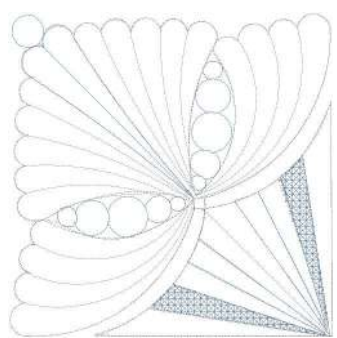

- 1. Off White (Mar:1181)
- 2. Blue - Med. (Hat:201)
- 3. Off White (Mar:1181)

Design5-12x12.pes
 11.61x11.61 inches; 16,527 stitches
 3 thread changes; 2 colors

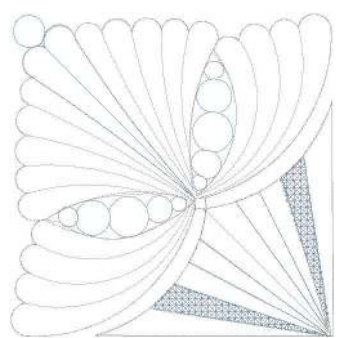

- 1. Off White (Mar:1181)
- 2. Blue - Med. (Hat:201)
- 3. Off White (Mar:1181)

Design5-13x13.pes
 12.99x12.99 inches; 18,318 stitches
 3 thread changes; 2 colors

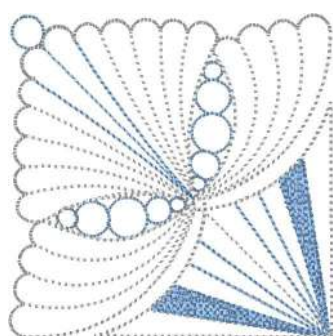

- 1. Off White (Mar:1181)
- 2. Blue - Med. (Hat:201)
- 3. Off White (Mar:1181)

Design5-4x4.pes

3.74x3.74 inches; 6,201 stitches
3 thread changes; 2 colors

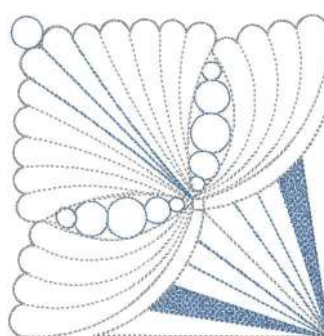

- 1. Off White (Mar:1181)
- 2. Blue - Med. (Hat:201)
- 3. Off White (Mar:1181)

Design5-5x5.pes

4.92x4.92 inches; 7,859 stitches
3 thread changes; 2 colors



- 1. Off White (Mar:1181)
- 2. Blue - Med. (Hat:201)
- 3. Off White (Mar:1181)

Design5-5x7.pes

7.68x3.83 inches; 12,877 stitches
3 thread changes; 2 colors

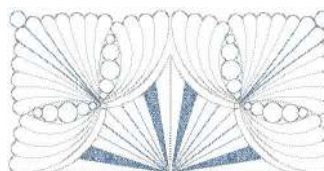

- 1. Off White (Mar:1181)
- 2. Blue - Med. (Hat:201)
- 3. Off White (Mar:1181)

Design5-6x10.pes

9.65x4.82 inches; 15,660 stitches
3 thread changes; 2 colors

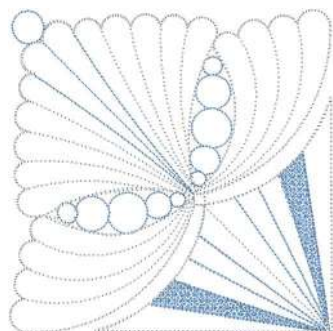

- 1. Off White (Mar:1181)
- 2. Blue - Med. (Hat:201)
- 3. Off White (Mar:1181)

Design5-6x6.pes

5.71x5.71 inches; 8,871 stitches
3 thread changes; 2 colors

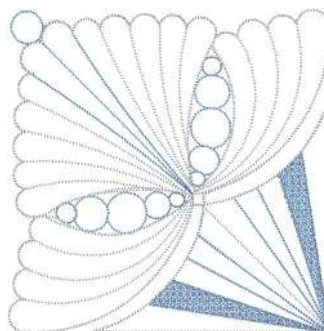

- 1. Off White (Mar:1181)
- 2. Blue - Med. (Hat:201)
- 3. Off White (Mar:1181)

Design5-8x8.pes

7.68x7.68 inches; 11,310 stitches
3 thread changes; 2 colors

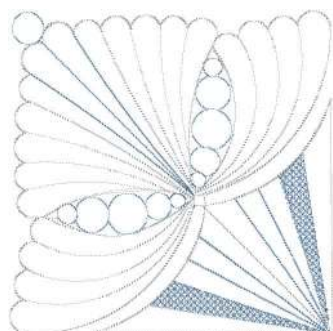

- 1. Off White (Mar:1181)
- 2. Blue - Med. (Hat:201)
- 3. Off White (Mar:1181)

Design5-9x9.pes

8.46x8.46 inches; 12,316 stitches
3 thread changes; 2 colors

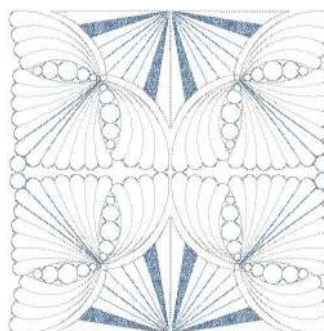

- 1. Off White (Mar:1181)
- 2. Blue - Med. (Hat:201)
- 3. Off White (Mar:1181)

Design6-10x10.pes

9.65x9.65 inches; 30,446 stitches
3 thread changes; 2 colors

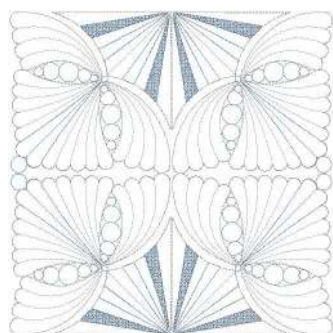

- 1. Off White (Mar:1181)
- 2. Blue - Med. (Hat:201)
- 3. Off White (Mar:1181)

Design6-12x12.pes

11.61x11.61 inches; 35,364 stitches
3 thread changes; 2 colors

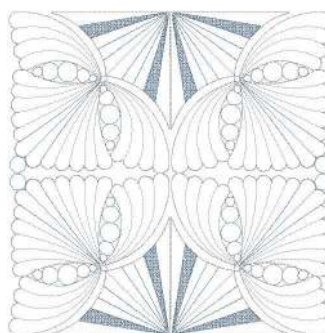

- 1. Off White (Mar:1181)
- 2. Blue - Med. (Hat:201)
- 3. Off White (Mar:1181)

Design6-13x13.pes

12.99x12.99 inches; 38,634 stitches
3 thread changes; 2 colors

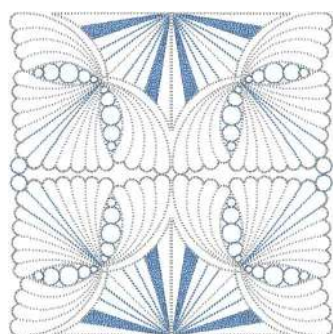

- 1. Off White (Mar:1181)
- 2. Blue - Med. (Hat:201)
- 3. Off White (Mar:1181)

Design6-8x8.pes

7.68x7.68 inches; 25,016 stitches
3 thread changes; 2 colors

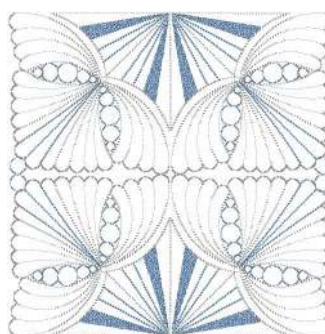

- 1. Off White (Mar:1181)
- 2. Blue - Med. (Hat:201)
- 3. Off White (Mar:1181)

Design6-9x9.pes

8.46x8.46 inches; 27,224 stitches
3 thread changes; 2 colors

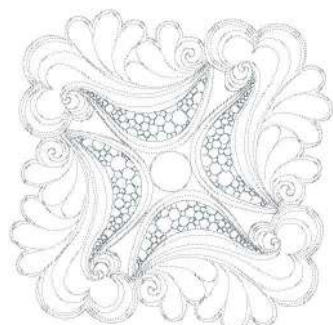

- 1. Off White (Mar:1181)
- 2. Glacier Blue (Mar:1094)
- 3. Off White (Mar:1181)

Design7-10x10.pes

9.65x9.65 inches; 20,703 stitches
3 thread changes; 2 colors

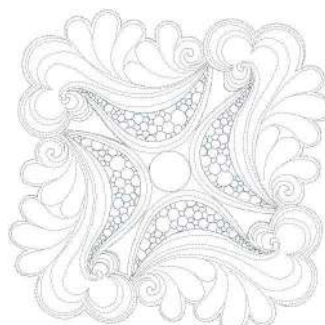

- 1. Off White (Mar:1181)
- 2. Glacier Blue (Mar:1094)
- 3. Off White (Mar:1181)

Design7-12x12.pes

11.61x11.61 inches; 24,011 stitches
3 thread changes; 2 colors

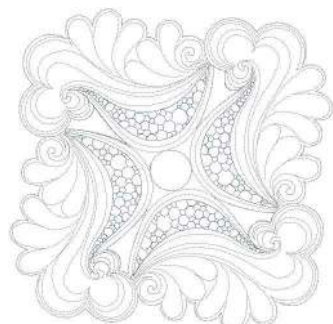

- 1. Off White (Mar:1181)
- 2. Glacier Blue (Mar:1094)
- 3. Off White (Mar:1181)

Design7-13x13.pes

12.99x12.99 inches; 26,274 stitches
3 thread changes; 2 colors

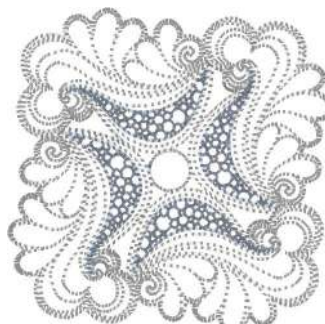

- 1. Off White (Mar:1181)
- 2. Glacier Blue (Mar:1094)
- 3. Off White (Mar:1181)

Design7-4x4.pes

3.74x3.74 inches; 10,304 stitches
3 thread changes; 2 colors

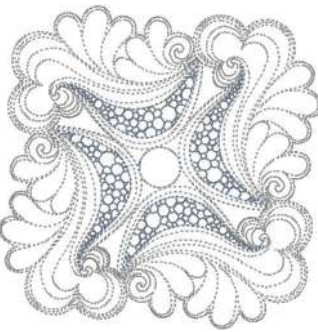

- 1. Off White (Mar:1181)
- 2. Glacier Blue (Mar:1094)
- 3. Off White (Mar:1181)

Design7-5x5.pes
4.92x4.92 inches; 12,468 stitches
3 thread changes; 2 colors

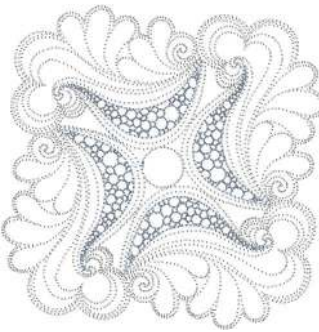

- 1. Off White (Mar:1181)
- 2. Glacier Blue (Mar:1094)
- 3. Off White (Mar:1181)

Design7-6x6.pes
5.71x5.71 inches; 13,951 stitches
3 thread changes; 2 colors

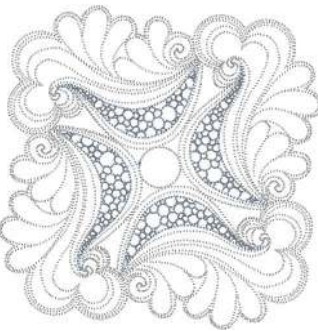

- 1. Off White (Mar:1181)
- 2. Glacier Blue (Mar:1094)
- 3. Off White (Mar:1181)

Design7-8x8.pes
7.68x7.68 inches; 17,425 stitches
3 thread changes; 2 colors

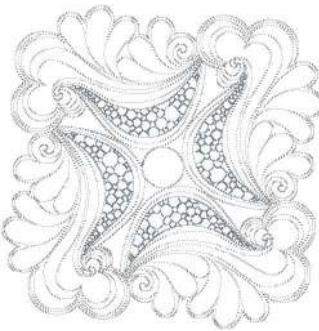

- 1. Off White (Mar:1181)
- 2. Glacier Blue (Mar:1094)
- 3. Off White (Mar:1181)

Design7-9x9.pes
8.46x8.46 inches; 18,760 stitches
3 thread changes; 2 colors

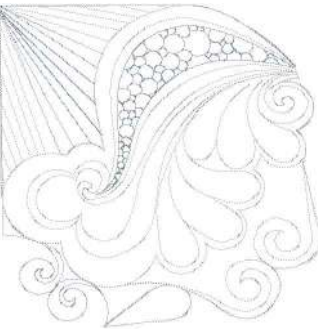

- 1. Off White (Mar:1181)
- 2. Glacier Blue (Mar:1094)
- 3. Off White (Mar:1181)

Design8-10x10.pes
9.65x9.65 inches; 11,862 stitches
3 thread changes; 2 colors



- 1. Off White (Mar:1181)
- 2. Glacier Blue (Mar:1094)
- 3. Off White (Mar:1181)

Design8-12x12.pes
11.61x11.61 inches; 13,958 stitches
3 thread changes; 2 colors

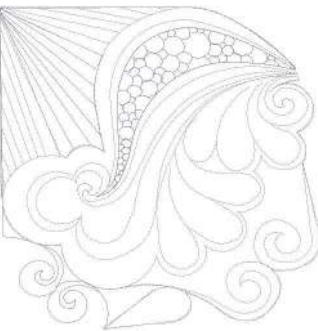

- 1. Off White (Mar:1181)
- 2. Glacier Blue (Mar:1094)
- 3. Off White (Mar:1181)

Design8-13x13.pes
12.99x12.99 inches; 15,420 stitches
3 thread changes; 2 colors



- 1. Off White (Mar:1181)
- 2. Glacier Blue (Mar:1094)
- 3. Off White (Mar:1181)

Design8-4x4.pes
3.74x3.74 inches; 5,434 stitches
3 thread changes; 2 colors



■ 1. Off White (Mar:1181)
■ 2. Glacier Blue (Mar:1094)
■ 3. Off White (Mar:1181)

Design8-5x5.pes
4.92x4.92 inches; 6,725 stitches
3 thread changes; 2 colors



■ 1. Off White (Mar:1181)
■ 2. Glacier Blue (Mar:1094)
■ 3. Off White (Mar:1181)

Design8-5x7.pes
7.68x3.84 inches; 11,166 stitches
3 thread changes; 2 colors



■ 1. Off White (Mar:1181)
■ 2. Glacier Blue (Mar:1094)
■ 3. Off White (Mar:1181)

Design8-6x10.pes
9.65x4.83 inches; 13,373 stitches
3 thread changes; 2 colors

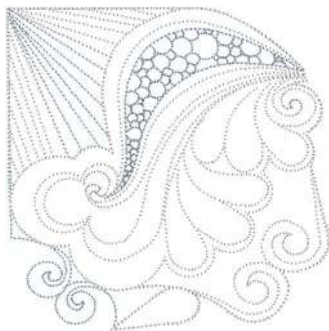

■ 1. Off White (Mar:1181)
■ 2. Glacier Blue (Mar:1094)
■ 3. Off White (Mar:1181)

Design8-6x6.pes
5.71x5.71 inches; 7,615 stitches
3 thread changes; 2 colors

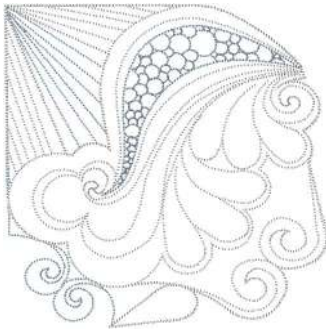

■ 1. Off White (Mar:1181)
■ 2. Glacier Blue (Mar:1094)
■ 3. Off White (Mar:1181)

Design8-8x8.pes
7.68x7.68 inches; 9,780 stitches
3 thread changes; 2 colors

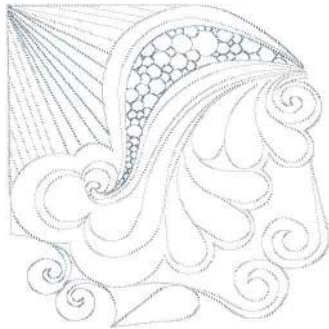

■ 1. Off White (Mar:1181)
■ 2. Glacier Blue (Mar:1094)
■ 3. Off White (Mar:1181)

Design8-9x9.pes
8.46x8.46 inches; 10,605 stitches
3 thread changes; 2 colors

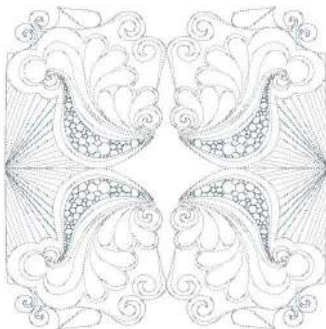

■ 1. Off White (Mar:1181)
■ 2. Glacier Blue (Mar:1094)
■ 3. Off White (Mar:1181)

Design9-10x10.pes
9.65x9.65 inches; 25,471 stitches
3 thread changes; 2 colors

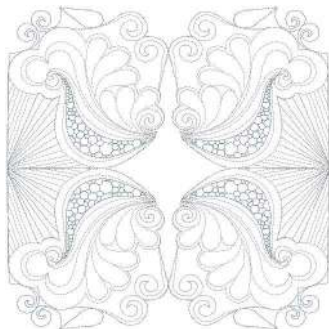

■ 1. Off White (Mar:1181)
■ 2. Glacier Blue (Mar:1094)
■ 3. Off White (Mar:1181)

Design9-12x12.pes
11.61x11.61 inches; 29,659 stitches
3 thread changes; 2 colors

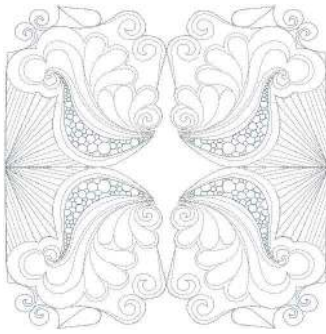

- 1. Off White (Mar:1181)
- 2. Glacier Blue (Mar:1094)
- 3. Off White (Mar:1181)

Design9-13x13.pes
12.99x12.99 inches; 32,574 stitches
3 thread changes; 2 colors

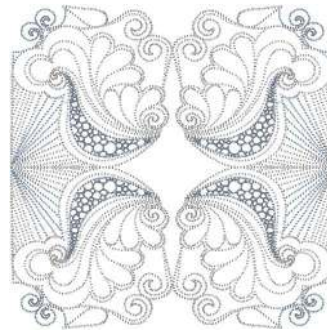

- 1. Off White (Mar:1181)
- 2. Glacier Blue (Mar:1094)
- 3. Off White (Mar:1181)

Design9-8x8.pes
7.68x7.68 inches; 21,354 stitches
3 thread changes; 2 colors

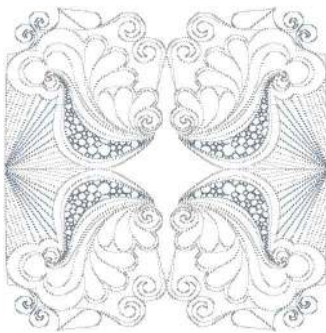

- 1. Off White (Mar:1181)
- 2. Glacier Blue (Mar:1094)
- 3. Off White (Mar:1181)

Design9-9x9.pes
8.46x8.46 inches; 23,056 stitches
3 thread changes; 2 colors