

■ 1. Algiers (Mar:1185)

**Design1-9x9.pes**  
8.46x8.46 inches; 39,385 stitches  
1 thread changes; 1 colors

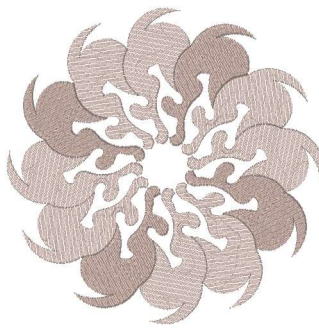

■ 1. Algiers (Mar:1185)

**Design10-10x10.pes**  
9.65x9.65 inches; 34,662 stitches  
1 thread changes; 1 colors

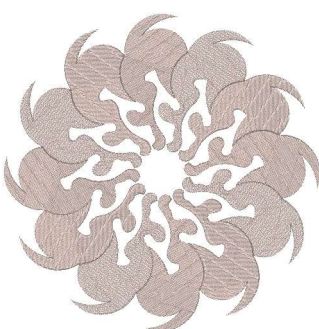

■ 1. Algiers (Mar:1185)

**Design10-12x12.pes**  
11.61x11.61 inches; 48,137 stitches  
1 thread changes; 1 colors

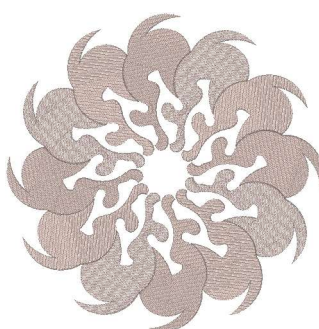

■ 1. Algiers (Mar:1185)

**Design10-13x13.pes**  
12.99x12.99 inches; 58,622 stitches  
1 thread changes; 1 colors

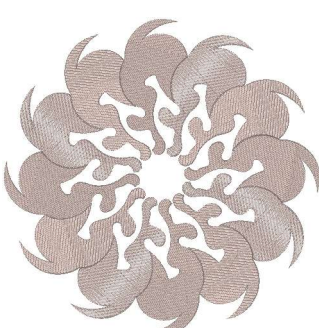

■ 1. Algiers (Mar:1185)

**Design10-14x14.pes**  
13.58x13.58 inches; 63,349 stitches  
1 thread changes; 1 colors

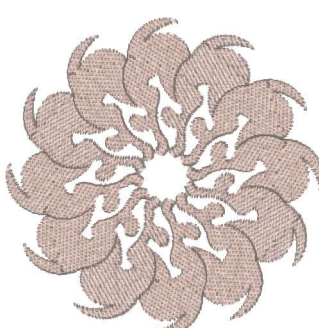

■ 1. Algiers (Mar:1185)

**Design10-4x4.pes**  
3.74x3.74 inches; 7,577 stitches  
1 thread changes; 1 colors

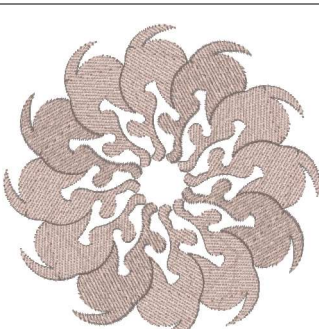

■ 1. Algiers (Mar:1185)

**Design10-5x5.pes**  
4.92x4.92 inches; 11,568 stitches  
1 thread changes; 1 colors

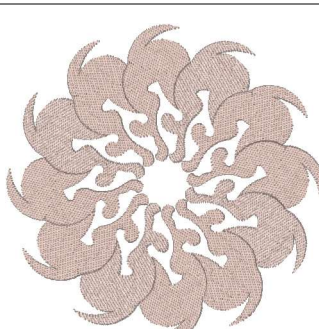

■ 1. Algiers (Mar:1185)

**Design10-6x6.pes**  
5.71x5.71 inches; 14,569 stitches  
1 thread changes; 1 colors

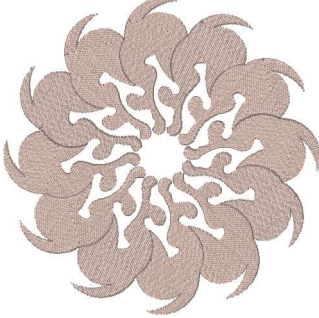

■ 1. Algiers (Mar:1185)

**Design10-8x8.pes**  
7.68x7.68 inches; 23,594 stitches  
1 thread changes; 1 colors

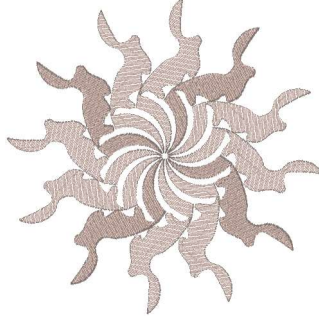

■ 1. Algiers (Mar:1185)

**Design11-10x10.pes**  
9.63x9.64 inches; 23,644 stitches  
1 thread changes; 1 colors

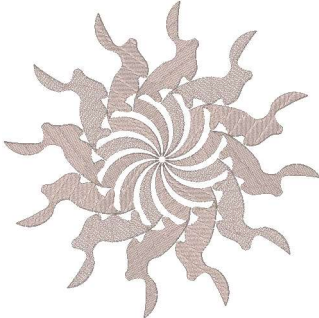

■ 1. Algiers (Mar:1185)

**Design11-12x12.pes**  
11.61x11.61 inches; 32,399 stitches  
1 thread changes; 1 colors

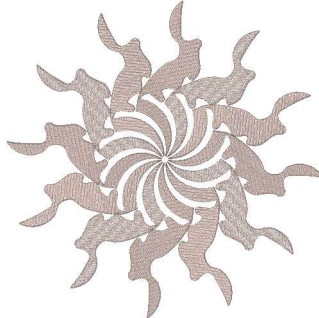

■ 1. Algiers (Mar:1185)

**Design11-13x13.pes**  
12.98x12.98 inches; 39,009 stitches  
1 thread changes; 1 colors

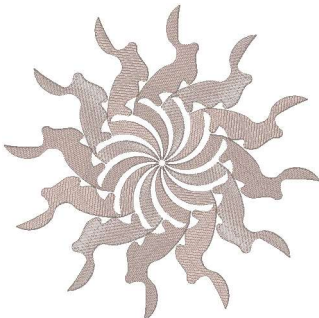

■ 1. Algiers (Mar:1185)

**Design11-14x14.pes**  
13.58x13.58 inches; 42,202 stitches  
1 thread changes; 1 colors

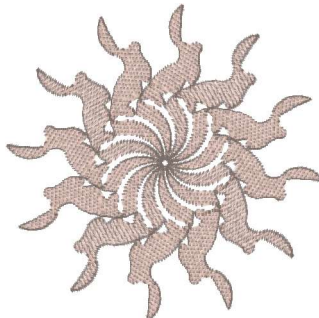

■ 1. Algiers (Mar:1185)

**Design11-4x4.pes**  
3.74x3.74 inches; 5,890 stitches  
1 thread changes; 1 colors

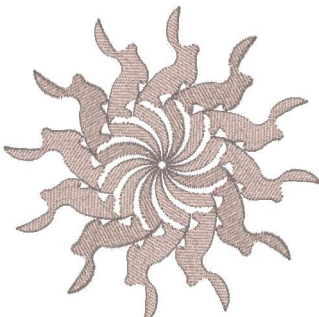

■ 1. Algiers (Mar:1185)

**Design11-5x5.pes**  
4.91x4.91 inches; 8,487 stitches  
1 thread changes; 1 colors

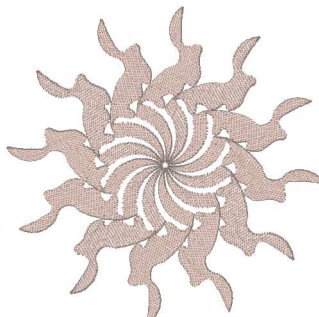

■ 1. Algiers (Mar:1185)

**Design11-6x6.pes**  
5.69x5.69 inches; 10,394 stitches  
1 thread changes; 1 colors

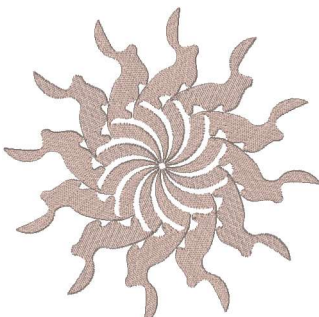

■ 1. Algiers (Mar:1185)

**Design11-8x8.pes**  
7.66x7.66 inches; 16,484 stitches  
1 thread changes; 1 colors

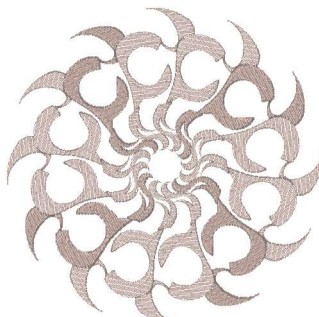

■ 1. Algiers (Mar:1185)

**Design12-10x10.pes**  
9.65x9.65 inches; 25,619 stitches  
1 thread changes; 1 colors

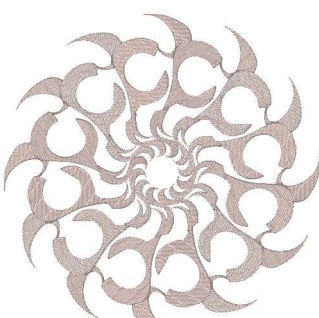

■ 1. Algiers (Mar:1185)

**Design12-12x12.pes**  
11.61x11.61 inches; 34,389 stitches  
1 thread changes; 1 colors

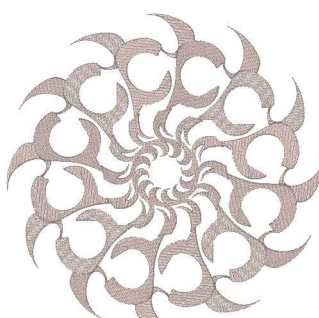

■ 1. Algiers (Mar:1185)

**Design12-13x13.pes**  
12.99x12.99 inches; 41,636 stitches  
1 thread changes; 1 colors

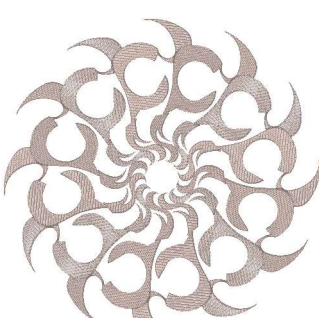

■ 1. Algiers (Mar:1185)

**Design12-14x14.pes**  
13.58x13.58 inches; 44,470 stitches  
1 thread changes; 1 colors

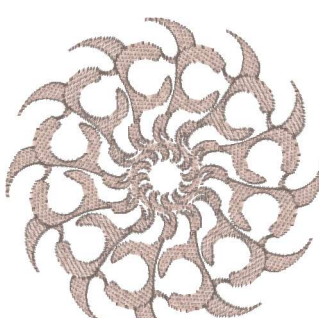

■ 1. Algiers (Mar:1185)

**Design12-4x4.pes**  
3.74x3.74 inches; 7,112 stitches  
1 thread changes; 1 colors

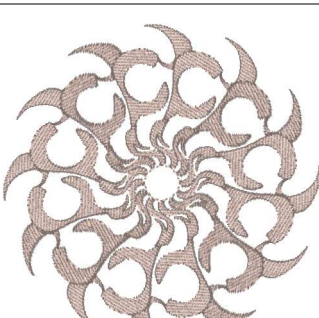

■ 1. Algiers (Mar:1185)

**Design12-5x5.pes**  
4.92x4.92 inches; 10,006 stitches  
1 thread changes; 1 colors

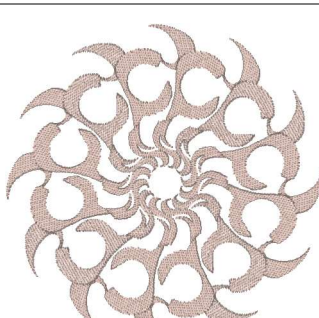

■ 1. Algiers (Mar:1185)

**Design12-6x6.pes**  
5.71x5.71 inches; 12,314 stitches  
1 thread changes; 1 colors

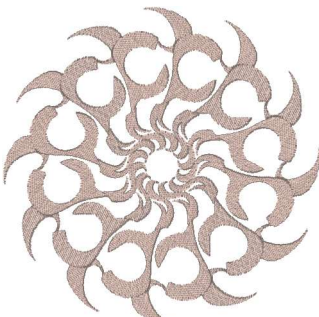

- 1. Algiers (Mar:1185)

**Design12-8x8.pes**  
7.68x7.68 inches; 18,524 stitches  
1 thread changes; 1 colors

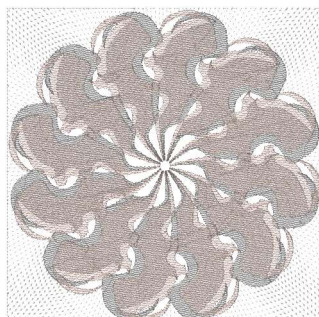

- 1. Off White (Mar:1181)
- 2. Leaden Gray (Mar:1320)
- 3. Algiers (Mar:1185)

**Design13-10x10.pes**  
9.65x9.65 inches; 50,944 stitches  
3 thread changes; 3 colors

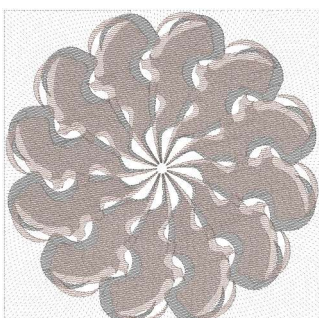

- 1. Off White (Mar:1181)
- 2. Leaden Gray (Mar:1320)
- 3. Algiers (Mar:1185)

**Design13-12x12.pes**  
11.61x11.61 inches; 70,054 stitches  
3 thread changes; 3 colors

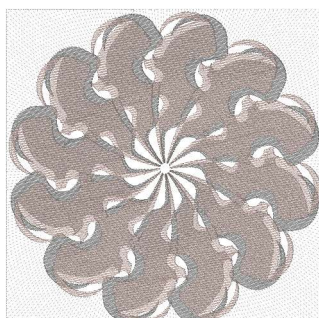

- 1. Off White (Mar:1181)
- 2. Leaden Gray (Mar:1320)
- 3. Algiers (Mar:1185)

**Design13-13x13.pes**  
12.99x12.99 inches; 85,635 stitches  
3 thread changes; 3 colors

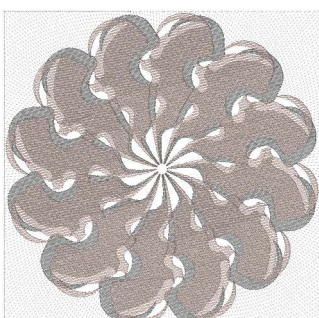

- 1. Off White (Mar:1181)
- 2. Leaden Gray (Mar:1320)
- 3. Algiers (Mar:1185)

**Design13-14x14.pes**  
13.58x13.58 inches; 92,290 stitches  
3 thread changes; 3 colors

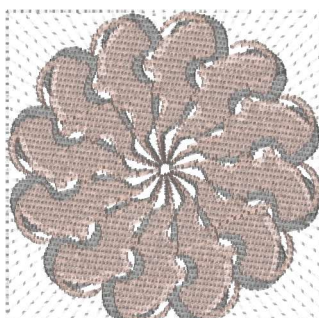

- 1. Off White (Mar:1181)
- 2. Leaden Gray (Mar:1320)
- 3. Algiers (Mar:1185)

**Design13-4x4.pes**  
3.74x3.74 inches; 11,614 stitches  
3 thread changes; 3 colors

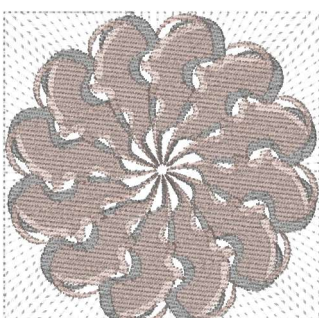

- 1. Off White (Mar:1181)
- 2. Leaden Gray (Mar:1320)
- 3. Algiers (Mar:1185)

**Design13-5x5.pes**  
4.92x4.92 inches; 17,305 stitches  
3 thread changes; 3 colors

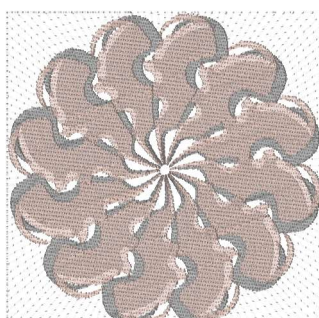

- 1. Off White (Mar:1181)
- 2. Leaden Gray (Mar:1320)
- 3. Algiers (Mar:1185)

**Design13-6x6.pes**  
5.71x5.71 inches; 21,724 stitches  
3 thread changes; 3 colors

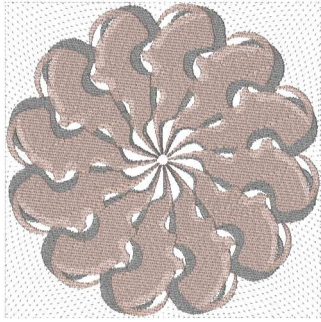

- 1. Off White (Mar:1181)
- 2. Leaden Gray (Mar:1320)
- 3. Algiers (Mar:1185)

**Design13-8x8.pes**

7.68x7.68 inches; 34,613 stitches  
3 thread changes; 3 colors

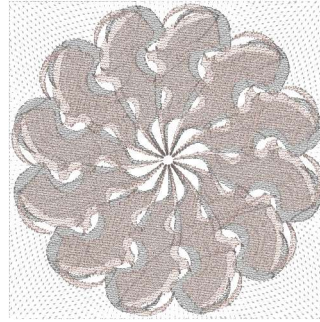

- 1. Off White (Mar:1181)
- 2. Leaden Gray (Mar:1320)
- 3. Algiers (Mar:1185)

**Design13-9x9.pes**

8.46x8.46 inches; 40,687 stitches  
3 thread changes; 3 colors

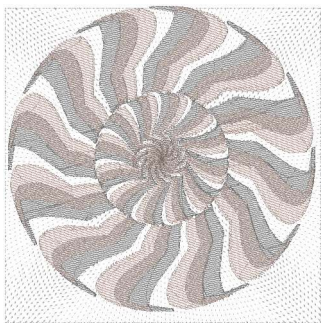

- 1. Off White (Mar:1181)
- 2. Leaden Gray (Mar:1320)
- 3. Algiers (Mar:1185)

**Design14-10x10.pes**

9.65x9.65 inches; 43,587 stitches  
3 thread changes; 3 colors

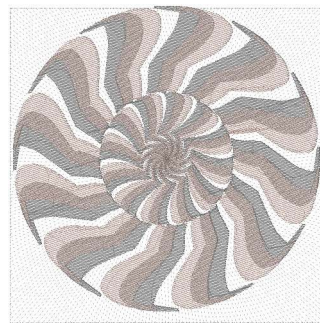

- 1. Off White (Mar:1181)
- 2. Leaden Gray (Mar:1320)
- 3. Algiers (Mar:1185)

**Design14-12x12.pes**

11.61x11.61 inches; 59,581 stitches  
3 thread changes; 3 colors

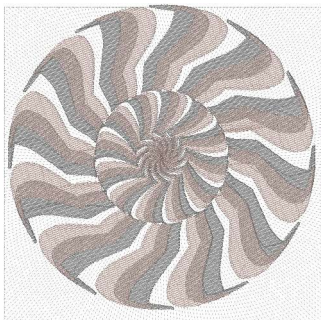

- 1. Off White (Mar:1181)
- 2. Leaden Gray (Mar:1320)
- 3. Algiers (Mar:1185)

**Design14-13x13.pes**

12.99x12.99 inches; 72,460 stitches  
3 thread changes; 3 colors

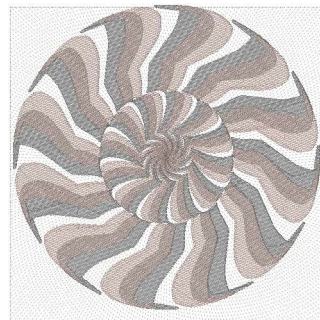

- 1. Off White (Mar:1181)
- 2. Leaden Gray (Mar:1320)
- 3. Algiers (Mar:1185)

**Design14-14x14.pes**

13.58x13.58 inches; 78,245 stitches  
3 thread changes; 3 colors

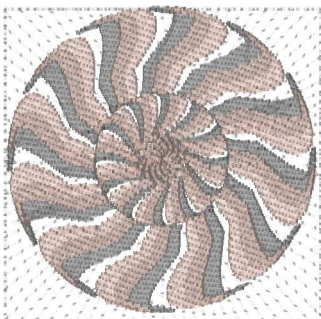

- 1. Off White (Mar:1181)
- 2. Leaden Gray (Mar:1320)
- 3. Algiers (Mar:1185)

**Design14-4x4.pes**

3.74x3.74 inches; 10,503 stitches  
3 thread changes; 3 colors

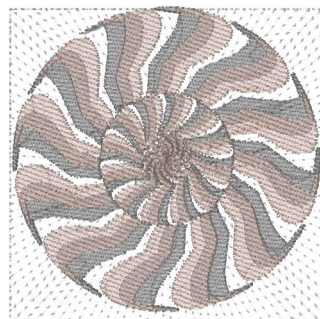

- 1. Off White (Mar:1181)
- 2. Leaden Gray (Mar:1320)
- 3. Algiers (Mar:1185)

**Design14-5x5.pes**

4.92x4.92 inches; 15,344 stitches  
3 thread changes; 3 colors

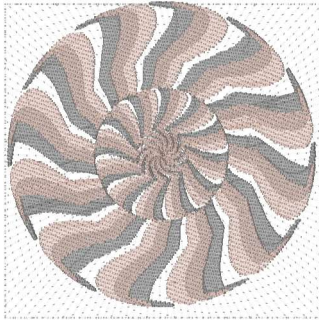

- 1. Off White (Mar:1181)
- 2. Leaden Gray (Mar:1320)
- 3. Algiers (Mar:1185)

**Design14-6x6.pes**

5.71x5.71 inches; 19,210 stitches  
3 thread changes; 3 colors

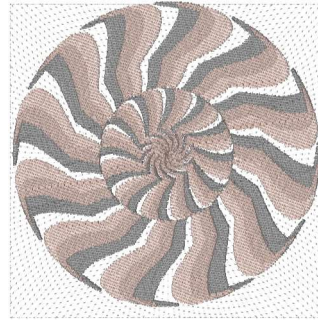

- 1. Off White (Mar:1181)
- 2. Leaden Gray (Mar:1320)
- 3. Algiers (Mar:1185)

**Design14-8x8.pes**

7.68x7.68 inches; 30,055 stitches  
3 thread changes; 3 colors

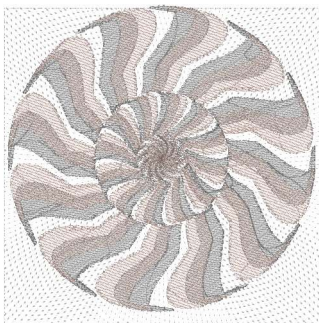

- 1. Off White (Mar:1181)
- 2. Leaden Gray (Mar:1320)
- 3. Algiers (Mar:1185)

**Design14-9x9.pes**

8.46x8.46 inches; 35,310 stitches  
3 thread changes; 3 colors

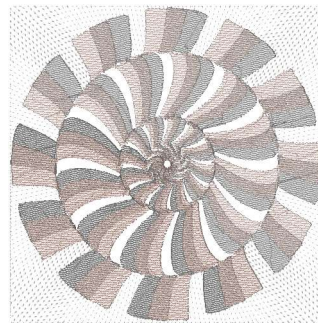

- 1. Off White (Mar:1181)
- 2. Leaden Gray (Mar:1320)
- 3. Algiers (Mar:1185)

**Design15-10x10.pes**

9.65x9.65 inches; 56,717 stitches  
3 thread changes; 3 colors

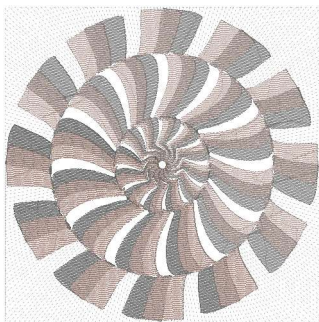

- 1. Off White (Mar:1181)
- 2. Leaden Gray (Mar:1320)
- 3. Algiers (Mar:1185)

**Design15-12x12.pes**

11.61x11.61 inches; 77,602 stitches  
3 thread changes; 3 colors

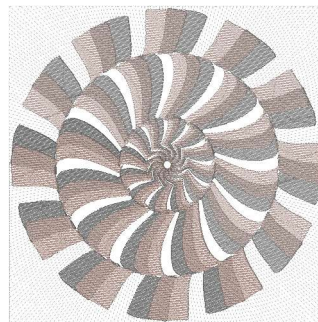

- 1. Off White (Mar:1181)
- 2. Leaden Gray (Mar:1320)
- 3. Algiers (Mar:1185)

**Design15-13x13.pes**

12.99x12.99 inches; 93,986 stitches  
3 thread changes; 3 colors

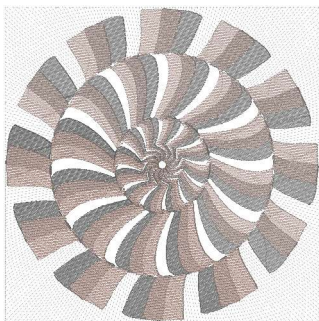

- 1. Off White (Mar:1181)
- 2. Leaden Gray (Mar:1320)
- 3. Algiers (Mar:1185)

**Design15-14x14.pes**

13.58x13.58 inches; 101,843 stitches  
3 thread changes; 3 colors

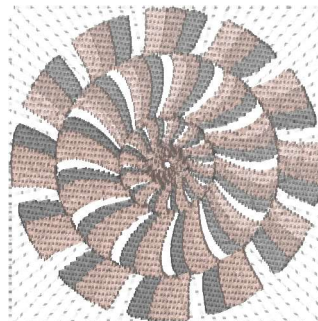

- 1. Off White (Mar:1181)
- 2. Leaden Gray (Mar:1320)
- 3. Algiers (Mar:1185)

**Design15-4x4.pes**

3.74x3.74 inches; 13,295 stitches  
3 thread changes; 3 colors

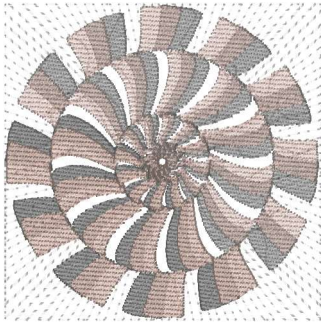

- 1. Off White (Mar:1181)
- 2. Leaden Gray (Mar:1320)
- 3. Algiers (Mar:1185)

**Design15-5x5.pes**  
4.92x4.92 inches; 19,670 stitches  
3 thread changes; 3 colors

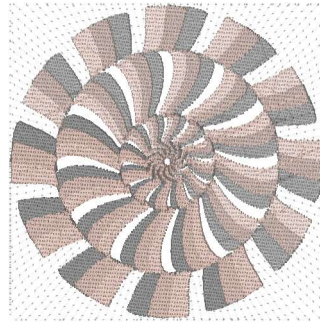

- 1. Off White (Mar:1181)
- 2. Leaden Gray (Mar:1320)
- 3. Algiers (Mar:1185)

**Design15-6x6.pes**  
5.71x5.71 inches; 24,526 stitches  
3 thread changes; 3 colors

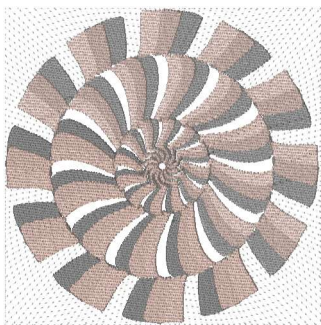

- 1. Off White (Mar:1181)
- 2. Leaden Gray (Mar:1320)
- 3. Algiers (Mar:1185)

**Design15-8x8.pes**  
7.68x7.68 inches; 38,975 stitches  
3 thread changes; 3 colors

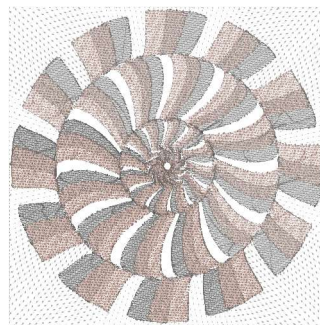

- 1. Off White (Mar:1181)
- 2. Leaden Gray (Mar:1320)
- 3. Algiers (Mar:1185)

**Design15-9x9.pes**  
8.46x8.46 inches; 45,592 stitches  
3 thread changes; 3 colors

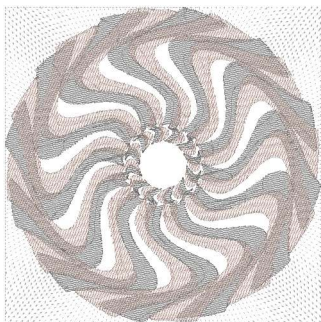

- 1. Off White (Mar:1181)
- 2. Leaden Gray (Mar:1320)
- 3. Algiers (Mar:1185)

**Design16-10x10.pes**  
9.65x9.65 inches; 41,649 stitches  
3 thread changes; 3 colors

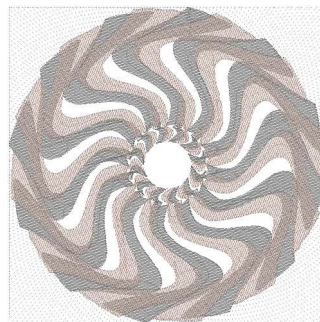

- 1. Off White (Mar:1181)
- 2. Leaden Gray (Mar:1320)
- 3. Algiers (Mar:1185)

**Design16-12x12.pes**  
11.63x11.61 inches; 57,209 stitches  
3 thread changes; 3 colors

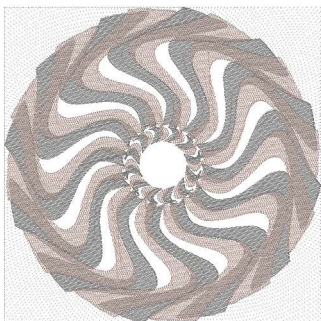

- 1. Off White (Mar:1181)
- 2. Leaden Gray (Mar:1320)
- 3. Algiers (Mar:1185)

**Design16-13x13.pes**  
13.00x12.99 inches; 69,506 stitches  
3 thread changes; 3 colors

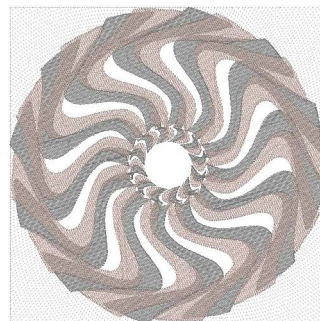

- 1. Off White (Mar:1181)
- 2. Leaden Gray (Mar:1320)
- 3. Algiers (Mar:1185)

**Design16-14x14.pes**  
13.59x13.58 inches; 75,119 stitches  
3 thread changes; 3 colors



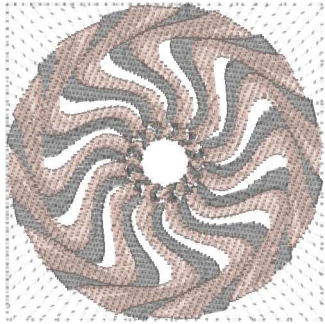

- 1. Off White (Mar:1181)
- 2. Leaden Gray (Mar:1320)
- 3. Algiers (Mar:1185)

**Design16-4x4.pes**

3.75x3.74 inches; 9,624 stitches  
3 thread changes; 3 colors

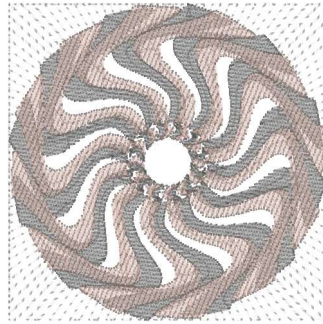

- 1. Off White (Mar:1181)
- 2. Leaden Gray (Mar:1320)
- 3. Algiers (Mar:1185)

**Design16-5x5.pes**

4.93x4.92 inches; 14,308 stitches  
3 thread changes; 3 colors

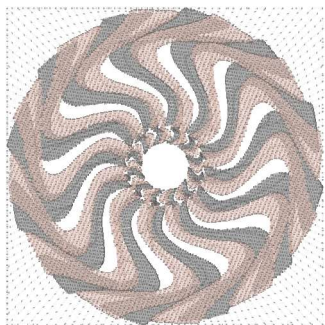

- 1. Off White (Mar:1181)
- 2. Leaden Gray (Mar:1320)
- 3. Algiers (Mar:1185)

**Design16-6x6.pes**

5.72x5.71 inches; 17,928 stitches  
3 thread changes; 3 colors

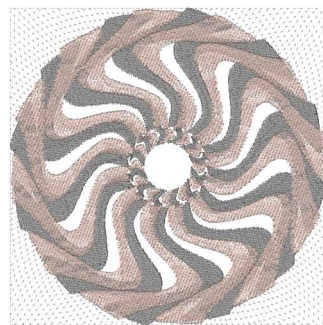

- 1. Off White (Mar:1181)
- 2. Leaden Gray (Mar:1320)
- 3. Algiers (Mar:1185)

**Design16-8x8.pes**

7.69x7.68 inches; 28,637 stitches  
3 thread changes; 3 colors

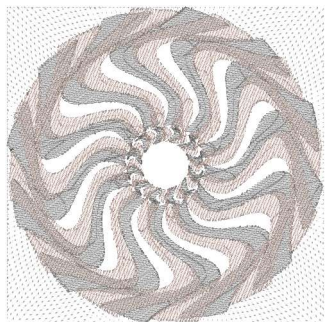

- 1. Off White (Mar:1181)
- 2. Leaden Gray (Mar:1320)
- 3. Algiers (Mar:1185)

**Design16-9x9.pes**

8.47x8.46 inches; 33,619 stitches  
3 thread changes; 3 colors

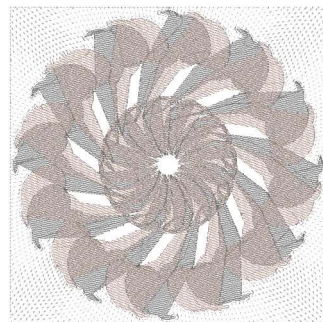

- 1. Off White (Mar:1181)
- 2. Leaden Gray (Mar:1320)
- 3. Algiers (Mar:1185)

**Design17-10x10.pes**

9.65x9.65 inches; 46,602 stitches  
3 thread changes; 3 colors

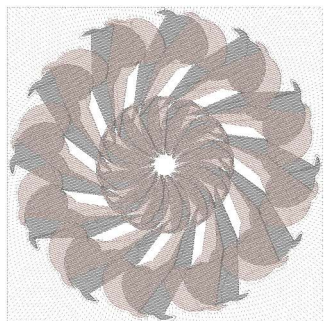

- 1. Off White (Mar:1181)
- 2. Leaden Gray (Mar:1320)
- 3. Algiers (Mar:1185)

**Design17-12x12.pes**

11.61x11.61 inches; 64,186 stitches  
3 thread changes; 3 colors

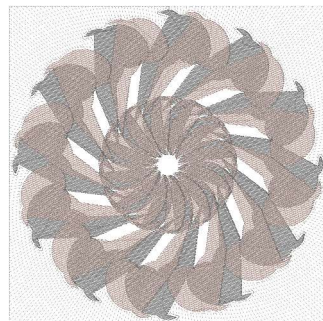

- 1. Off White (Mar:1181)
- 2. Leaden Gray (Mar:1320)
- 3. Algiers (Mar:1185)

**Design17-13x13.pes**

12.99x12.99 inches; 78,193 stitches  
3 thread changes; 3 colors

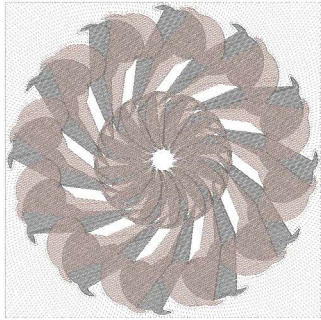

- 1. Off White (Mar:1181)
- 2. Leaden Gray (Mar:1320)
- 3. Algiers (Mar:1185)

**Design17-14x14.pes**  
13.58x13.58 inches; 84,624 stitches  
3 thread changes; 3 colors

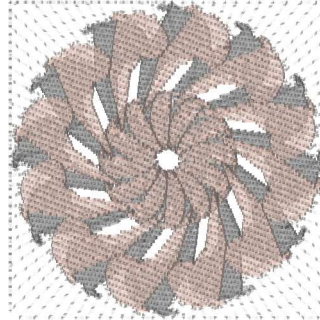

- 1. Off White (Mar:1181)
- 2. Leaden Gray (Mar:1320)
- 3. Algiers (Mar:1185)

**Design17-4x4.pes**  
3.74x3.74 inches; 10,190 stitches  
3 thread changes; 3 colors

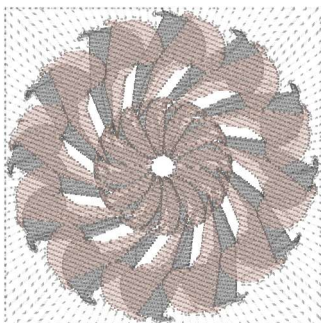

- 1. Off White (Mar:1181)
- 2. Leaden Gray (Mar:1320)
- 3. Algiers (Mar:1185)

**Design17-5x5.pes**  
4.92x4.92 inches; 15,433 stitches  
3 thread changes; 3 colors

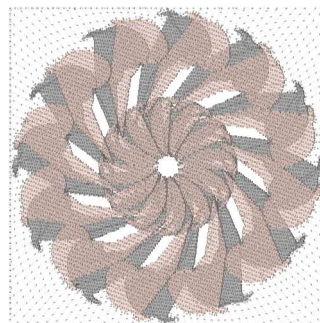

- 1. Off White (Mar:1181)
- 2. Leaden Gray (Mar:1320)
- 3. Algiers (Mar:1185)

**Design17-6x6.pes**  
5.71x5.71 inches; 19,550 stitches  
3 thread changes; 3 colors

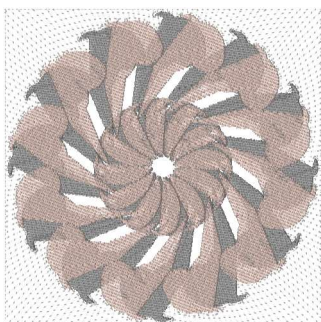

- 1. Off White (Mar:1181)
- 2. Leaden Gray (Mar:1320)
- 3. Algiers (Mar:1185)

**Design17-8x8.pes**  
7.68x7.68 inches; 31,569 stitches  
3 thread changes; 3 colors

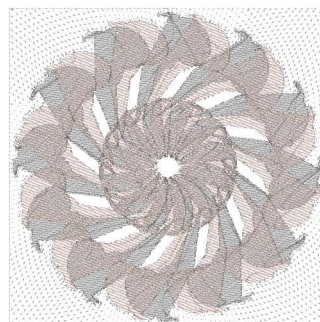

- 1. Off White (Mar:1181)
- 2. Leaden Gray (Mar:1320)
- 3. Algiers (Mar:1185)

**Design17-9x9.pes**  
8.46x8.46 inches; 37,210 stitches  
3 thread changes; 3 colors

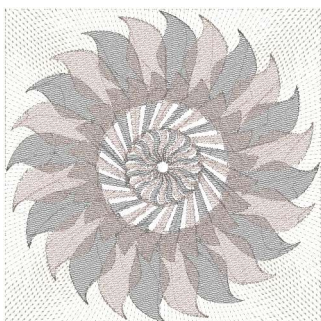

- 1. Tinted Chrome (Mar:1299)
- 2. Leaden Gray (Mar:1320)
- 3. Algiers (Mar:1185)

**Design18-10x10.pes**  
9.65x9.65 inches; 39,951 stitches  
3 thread changes; 3 colors

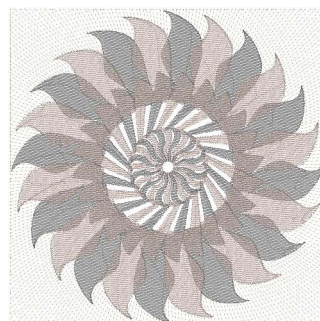

- 1. Tinted Chrome (Mar:1299)
- 2. Leaden Gray (Mar:1320)
- 3. Algiers (Mar:1185)

**Design18-12x12.pes**  
11.61x11.61 inches; 54,703 stitches  
3 thread changes; 3 colors

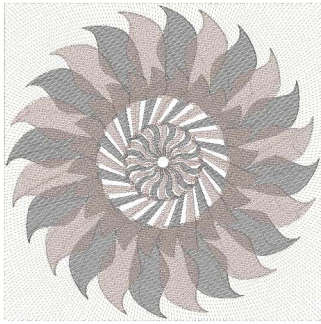

- 1. Tinted Chrome (Mar:1299)
- 2. Leaden Gray (Mar:1320)
- 3. Algiers (Mar:1185)

**Design18-13x13.pes**  
12.99x12.99 inches; 66,286 stitches  
3 thread changes; 3 colors



- 1. Tinted Chrome (Mar:1299)
- 2. Leaden Gray (Mar:1320)
- 3. Algiers (Mar:1185)

**Design18-14x14.pes**  
13.58x13.58 inches; 71,779 stitches  
3 thread changes; 3 colors

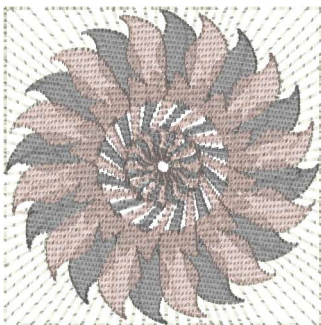

- 1. Tinted Chrome (Mar:1299)
- 2. Leaden Gray (Mar:1320)
- 3. Algiers (Mar:1185)

**Design18-4x4.pes**  
3.74x3.74 inches; 9,411 stitches  
3 thread changes; 3 colors

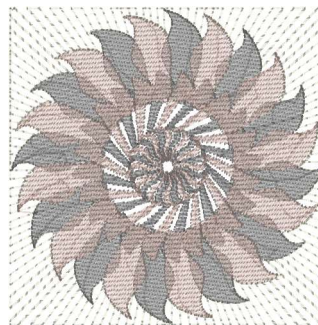

- 1. Tinted Chrome (Mar:1299)
- 2. Leaden Gray (Mar:1320)
- 3. Algiers (Mar:1185)

**Design18-5x5.pes**  
4.92x4.92 inches; 13,881 stitches  
3 thread changes; 3 colors

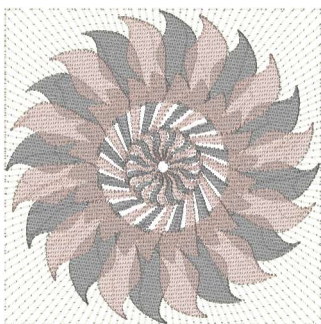

- 1. Tinted Chrome (Mar:1299)
- 2. Leaden Gray (Mar:1320)
- 3. Algiers (Mar:1185)

**Design18-6x6.pes**  
5.71x5.71 inches; 17,227 stitches  
3 thread changes; 3 colors

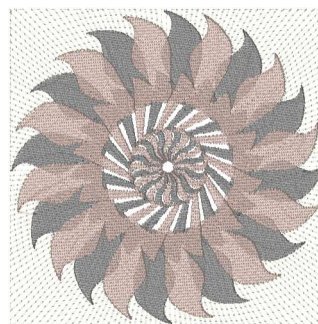

- 1. Tinted Chrome (Mar:1299)
- 2. Leaden Gray (Mar:1320)
- 3. Algiers (Mar:1185)

**Design18-8x8.pes**  
7.68x7.68 inches; 27,511 stitches  
3 thread changes; 3 colors

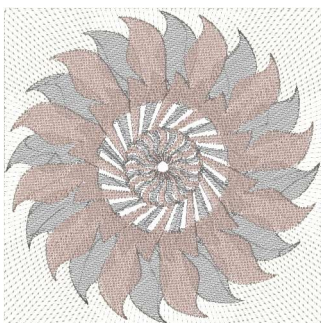

- 1. Tinted Chrome (Mar:1299)
- 2. Leaden Gray (Mar:1320)
- 3. Algiers (Mar:1185)

**Design18-9x9.pes**  
8.46x8.46 inches; 32,094 stitches  
3 thread changes; 3 colors

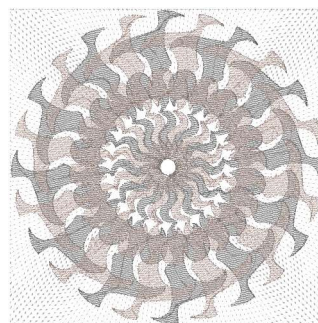

- 1. Off White (Mar:1181)
- 2. Leaden Gray (Mar:1320)
- 3. Algiers (Mar:1185)

**Design19-10x10.pes**  
9.65x9.65 inches; 43,603 stitches  
3 thread changes; 3 colors

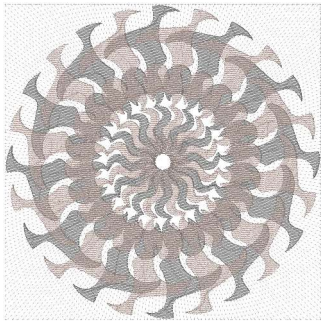

- 1. Off White (Mar:1181)
- 2. Leaden Gray (Mar:1320)
- 3. Algiers (Mar:1185)

**Design19-12x12.pes**  
11.61x11.61 inches; 58,984 stitches  
3 thread changes; 3 colors

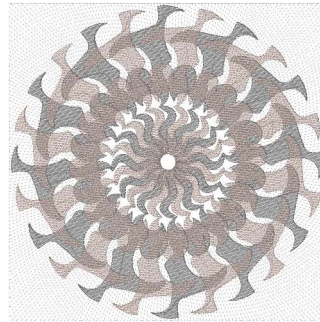

- 1. Off White (Mar:1181)
- 2. Leaden Gray (Mar:1320)
- 3. Algiers (Mar:1185)

**Design19-13x13.pes**  
12.99x12.99 inches; 70,832 stitches  
3 thread changes; 3 colors

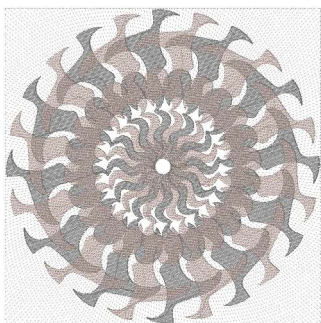

- 1. Off White (Mar:1181)
- 2. Leaden Gray (Mar:1320)
- 3. Algiers (Mar:1185)

**Design19-14x14.pes**  
13.58x13.58 inches; 76,708 stitches  
3 thread changes; 3 colors

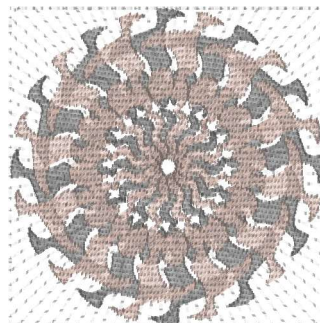

- 1. Off White (Mar:1181)
- 2. Leaden Gray (Mar:1320)
- 3. Algiers (Mar:1185)

**Design19-4x4.pes**  
3.74x3.74 inches; 11,400 stitches  
3 thread changes; 3 colors

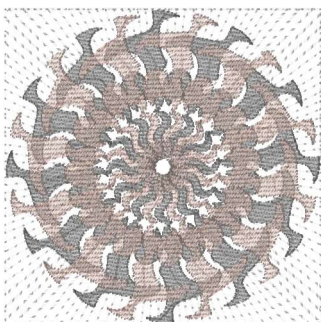

- 1. Off White (Mar:1181)
- 2. Leaden Gray (Mar:1320)
- 3. Algiers (Mar:1185)

**Design19-5x5.pes**  
4.92x4.92 inches; 16,208 stitches  
3 thread changes; 3 colors

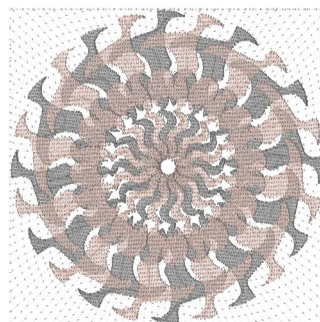

- 1. Off White (Mar:1181)
- 2. Leaden Gray (Mar:1320)
- 3. Algiers (Mar:1185)

**Design19-6x6.pes**  
5.71x5.71 inches; 19,915 stitches  
3 thread changes; 3 colors

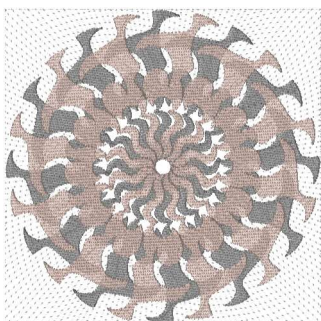

- 1. Off White (Mar:1181)
- 2. Leaden Gray (Mar:1320)
- 3. Algiers (Mar:1185)

**Design19-8x8.pes**  
7.68x7.68 inches; 30,601 stitches  
3 thread changes; 3 colors

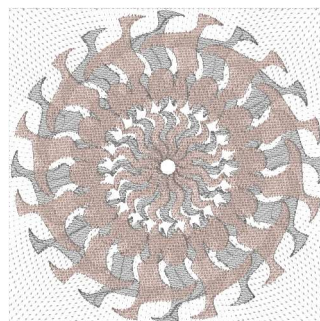

- 1. Off White (Mar:1181)
- 2. Leaden Gray (Mar:1320)
- 3. Algiers (Mar:1185)

**Design19-9x9.pes**  
8.46x8.46 inches; 35,496 stitches  
3 thread changes; 3 colors

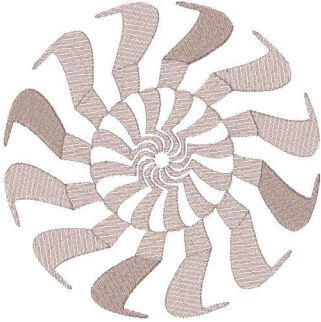

■ 1. Algiers (Mar:1185)

**Design2-10x10.pes**  
9.65x9.65 inches; 29,088 stitches  
1 thread changes; 1 colors

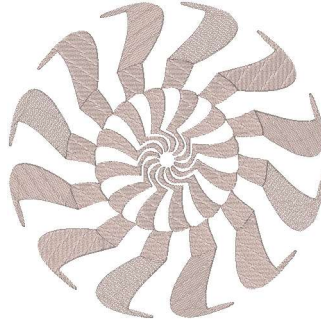

■ 1. Algiers (Mar:1185)

**Design2-12x12.pes**  
11.62x11.62 inches; 40,135 stitches  
1 thread changes; 1 colors

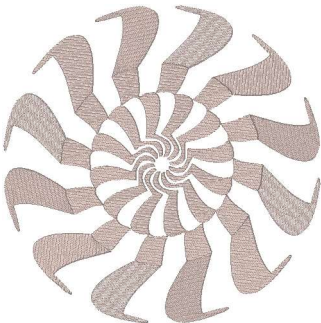

■ 1. Algiers (Mar:1185)

**Design2-13x13.pes**  
13.00x13.00 inches; 48,584 stitches  
1 thread changes; 1 colors

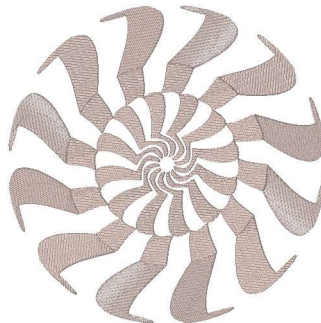

■ 1. Algiers (Mar:1185)

**Design2-14x14.pes**  
13.59x13.59 inches; 52,768 stitches  
1 thread changes; 1 colors

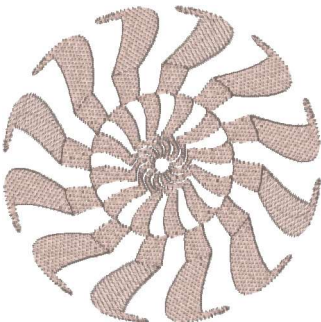

■ 1. Algiers (Mar:1185)

**Design2-4x4.pes**  
3.75x3.75 inches; 6,821 stitches  
1 thread changes; 1 colors

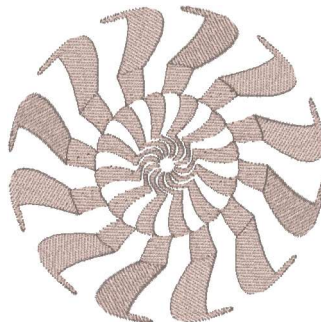

■ 1. Algiers (Mar:1185)

**Design2-5x5.pes**  
4.93x4.93 inches; 10,102 stitches  
1 thread changes; 1 colors

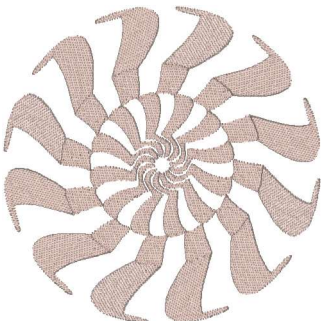

■ 1. Algiers (Mar:1185)

**Design2-6x6.pes**  
5.72x5.72 inches; 12,587 stitches  
1 thread changes; 1 colors

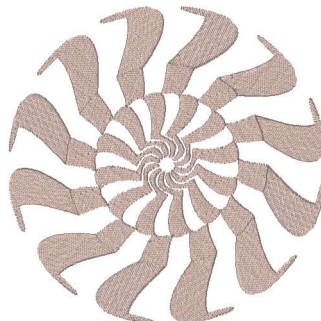

■ 1. Algiers (Mar:1185)

**Design2-8x8.pes**  
7.69x7.69 inches; 19,932 stitches  
1 thread changes; 1 colors

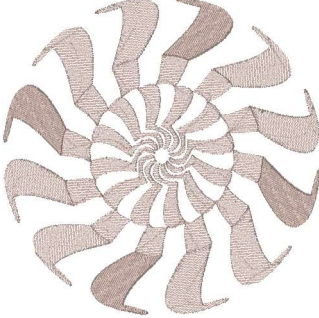

- 1. Algiers (Mar:1185)

**Design2-9x9.pes**  
8.47x8.47 inches; 23,553 stitches  
1 thread changes; 1 colors

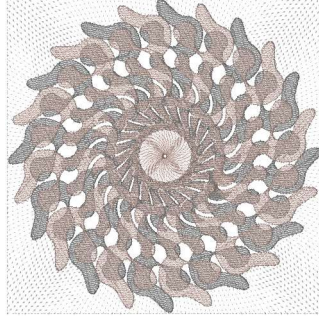

- 1. Off White (Mar:1181)
- 2. Leaden Gray (Mar:1320)
- 3. Algiers (Mar:1185)

**Design20-10x10.pes**  
9.65x9.65 inches; 73,649 stitches  
3 thread changes; 3 colors

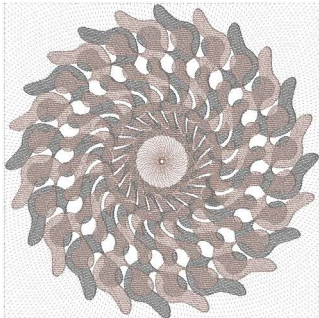

- 1. Off White (Mar:1181)
- 2. Leaden Gray (Mar:1320)
- 3. Algiers (Mar:1185)

**Design20-12x12.pes**  
11.61x11.61 inches; 98,354 stitches  
3 thread changes; 3 colors

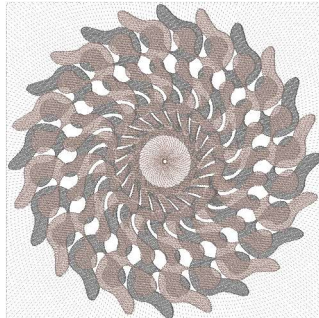

- 1. Off White (Mar:1181)
- 2. Leaden Gray (Mar:1320)
- 3. Algiers (Mar:1185)

**Design20-13x13.pes**  
12.99x12.99 inches; 117,388 stitches  
3 thread changes; 3 colors

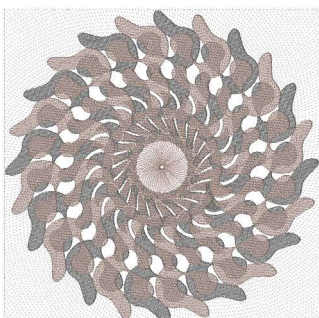

- 1. Off White (Mar:1181)
- 2. Leaden Gray (Mar:1320)
- 3. Algiers (Mar:1185)

**Design20-14x14.pes**  
13.58x13.58 inches; 126,149 stitches  
3 thread changes; 3 colors

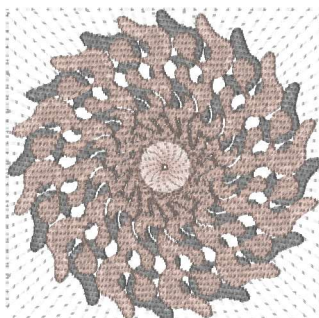

- 1. Off White (Mar:1181)
- 2. Leaden Gray (Mar:1320)
- 3. Algiers (Mar:1185)

**Design20-4x4.pes**  
3.74x3.74 inches; 20,912 stitches  
3 thread changes; 3 colors

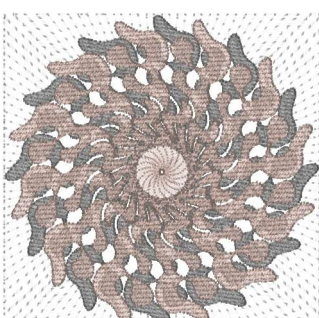

- 1. Off White (Mar:1181)
- 2. Leaden Gray (Mar:1320)
- 3. Algiers (Mar:1185)

**Design20-5x5.pes**  
4.92x4.92 inches; 28,870 stitches  
3 thread changes; 3 colors

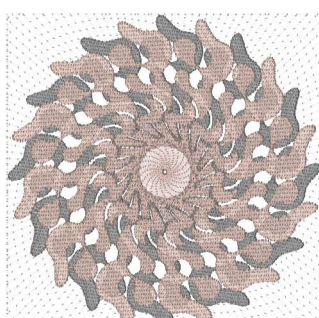

- 1. Off White (Mar:1181)
- 2. Leaden Gray (Mar:1320)
- 3. Algiers (Mar:1185)

**Design20-6x6.pes**  
5.71x5.71 inches; 35,278 stitches  
3 thread changes; 3 colors

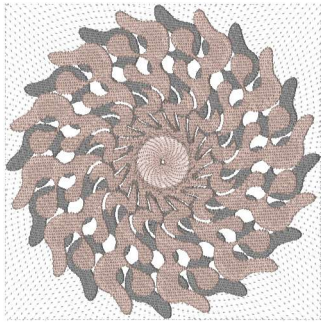

- 1. Off White (Mar:1181)
- 2. Leaden Gray (Mar:1320)
- 3. Algiers (Mar:1185)

**Design20-8x8.pes**  
7.68x7.68 inches; 52,652 stitches  
3 thread changes; 3 colors

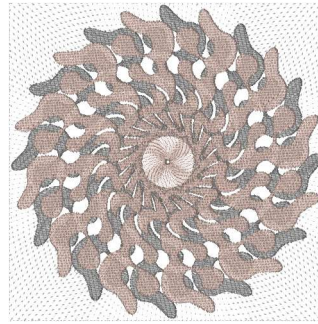

- 1. Off White (Mar:1181)
- 2. Leaden Gray (Mar:1320)
- 3. Algiers (Mar:1185)

**Design20-9x9.pes**  
8.46x8.46 inches; 60,591 stitches  
3 thread changes; 3 colors

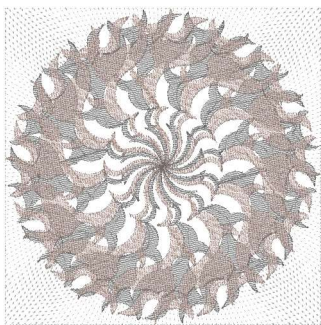

- 1. Off White (Mar:1181)
- 2. Leaden Gray (Mar:1320)
- 3. Algiers (Mar:1185)

**Design21-10x10.pes**  
9.65x9.65 inches; 46,158 stitches  
3 thread changes; 3 colors

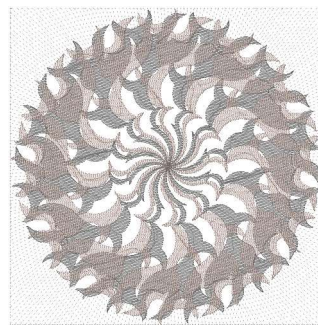

- 1. Off White (Mar:1181)
- 2. Leaden Gray (Mar:1320)
- 3. Algiers (Mar:1185)

**Design21-12x12.pes**  
11.61x11.61 inches; 61,980 stitches  
3 thread changes; 3 colors

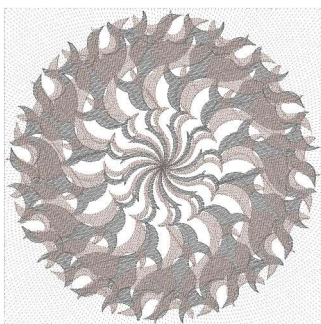

- 1. Off White (Mar:1181)
- 2. Leaden Gray (Mar:1320)
- 3. Algiers (Mar:1185)

**Design21-13x13.pes**  
12.99x12.99 inches; 74,259 stitches  
3 thread changes; 3 colors

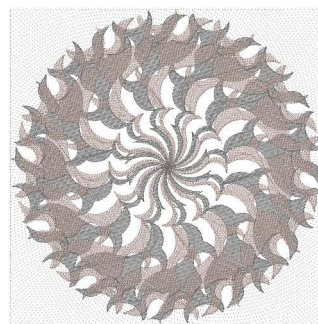

- 1. Off White (Mar:1181)
- 2. Leaden Gray (Mar:1320)
- 3. Algiers (Mar:1185)

**Design21-14x14.pes**  
13.58x13.58 inches; 79,750 stitches  
3 thread changes; 3 colors

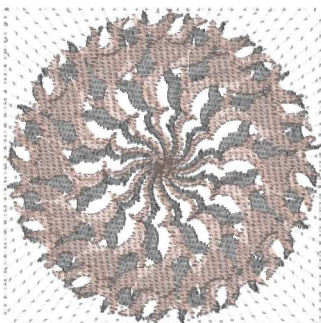

- 1. Off White (Mar:1181)
- 2. Leaden Gray (Mar:1320)
- 3. Algiers (Mar:1185)

**Design21-4x4.pes**  
3.74x3.74 inches; 12,471 stitches  
3 thread changes; 3 colors

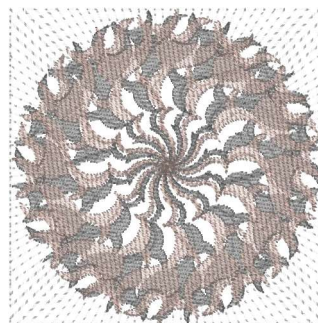

- 1. Off White (Mar:1181)
- 2. Leaden Gray (Mar:1320)
- 3. Algiers (Mar:1185)

**Design21-5x5.pes**  
4.92x4.92 inches; 17,619 stitches  
3 thread changes; 3 colors

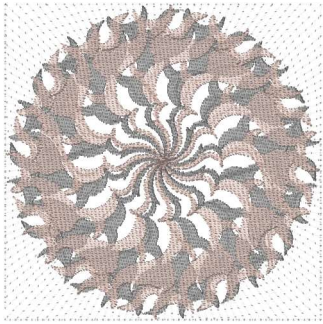

- 1. Off White (Mar:1181)
- 2. Leaden Gray (Mar:1320)
- 3. Algiers (Mar:1185)

**Design21-6x6.pes**

5.71x5.71 inches; 21,456 stitches  
3 thread changes; 3 colors

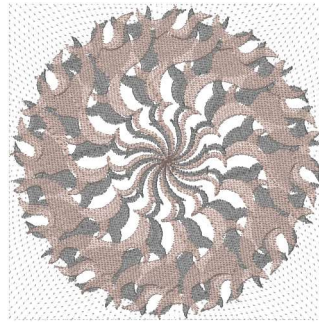

- 1. Off White (Mar:1181)
- 2. Leaden Gray (Mar:1320)
- 3. Algiers (Mar:1185)

**Design21-8x8.pes**

7.68x7.68 inches; 32,844 stitches  
3 thread changes; 3 colors

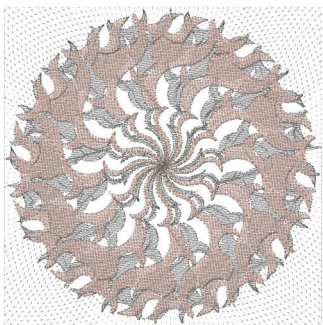

- 1. Off White (Mar:1181)
- 2. Leaden Gray (Mar:1320)
- 3. Algiers (Mar:1185)

**Design21-9x9.pes**

8.46x8.46 inches; 37,988 stitches  
3 thread changes; 3 colors

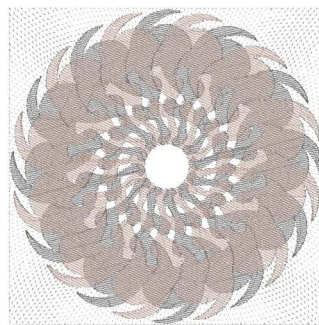

- 1. Off White (Mar:1181)
- 2. Leaden Gray (Mar:1320)
- 3. Algiers (Mar:1185)

**Design22-10x10.pes**

9.65x9.65 inches; 50,553 stitches  
3 thread changes; 3 colors

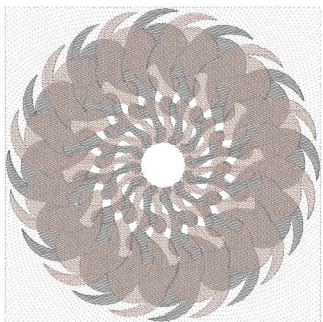

- 1. Off White (Mar:1181)
- 2. Leaden Gray (Mar:1320)
- 3. Algiers (Mar:1185)

**Design22-12x12.pes**

11.61x11.61 inches; 69,674 stitches  
3 thread changes; 3 colors

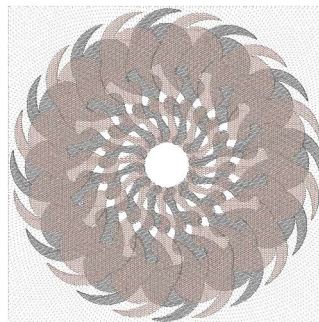

- 1. Off White (Mar:1181)
- 2. Leaden Gray (Mar:1320)
- 3. Algiers (Mar:1185)

**Design22-13x13.pes**

12.99x12.99 inches; 84,459 stitches  
3 thread changes; 3 colors

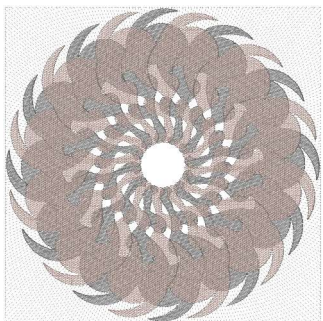

- 1. Off White (Mar:1181)
- 2. Leaden Gray (Mar:1320)
- 3. Algiers (Mar:1185)

**Design22-14x14.pes**

13.58x13.58 inches; 91,402 stitches  
3 thread changes; 3 colors

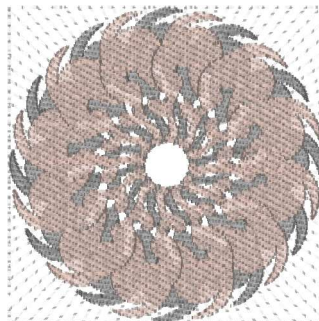

- 1. Off White (Mar:1181)
- 2. Leaden Gray (Mar:1320)
- 3. Algiers (Mar:1185)

**Design22-4x4.pes**

3.74x3.74 inches; 11,695 stitches  
3 thread changes; 3 colors



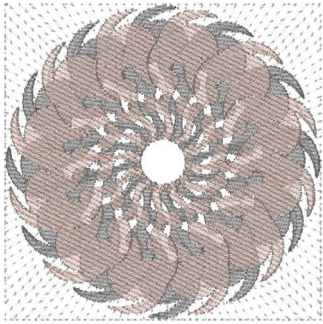

- 1. Off White (Mar:1181)
- 2. Leaden Gray (Mar:1320)
- 3. Algiers (Mar:1185)

**Design22-5x5.pes**  
4.92x4.92 inches; 17,357 stitches  
3 thread changes; 3 colors

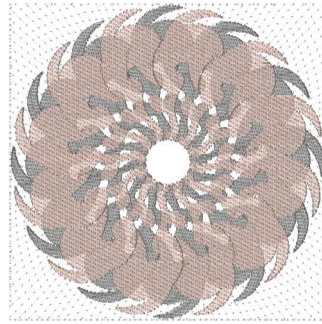

- 1. Off White (Mar:1181)
- 2. Leaden Gray (Mar:1320)
- 3. Algiers (Mar:1185)

**Design22-6x6.pes**  
5.71x5.71 inches; 21,756 stitches  
3 thread changes; 3 colors

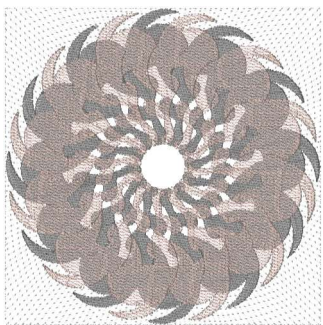

- 1. Off White (Mar:1181)
- 2. Leaden Gray (Mar:1320)
- 3. Algiers (Mar:1185)

**Design22-8x8.pes**  
7.68x7.68 inches; 34,799 stitches  
3 thread changes; 3 colors

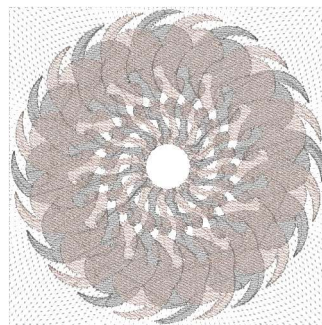

- 1. Off White (Mar:1181)
- 2. Leaden Gray (Mar:1320)
- 3. Algiers (Mar:1185)

**Design22-9x9.pes**  
8.46x8.46 inches; 40,617 stitches  
3 thread changes; 3 colors

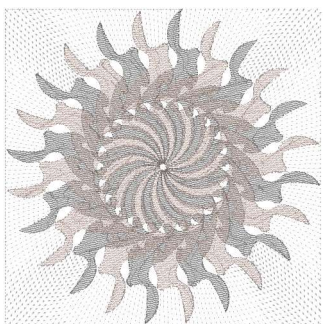

- 1. Off White (Mar:1181)
- 2. Leaden Gray (Mar:1320)
- 3. Algiers (Mar:1185)

**Design23-10x10.pes**  
9.65x9.65 inches; 35,456 stitches  
3 thread changes; 3 colors

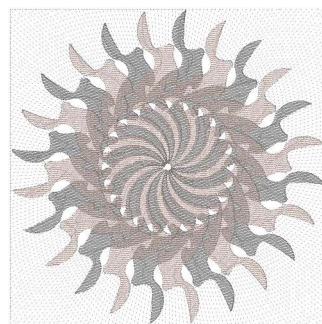

- 1. Off White (Mar:1181)
- 2. Leaden Gray (Mar:1320)
- 3. Algiers (Mar:1185)

**Design23-12x12.pes**  
11.61x11.61 inches; 48,000 stitches  
3 thread changes; 3 colors

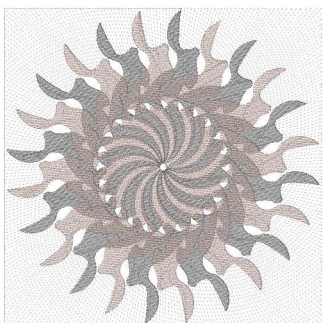

- 1. Off White (Mar:1181)
- 2. Leaden Gray (Mar:1320)
- 3. Algiers (Mar:1185)

**Design23-13x13.pes**  
12.99x12.99 inches; 58,202 stitches  
3 thread changes; 3 colors

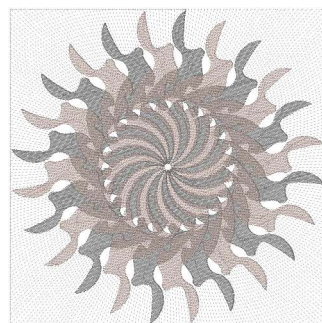

- 1. Off White (Mar:1181)
- 2. Leaden Gray (Mar:1320)
- 3. Algiers (Mar:1185)

**Design23-14x14.pes**  
13.58x13.58 inches; 62,624 stitches  
3 thread changes; 3 colors

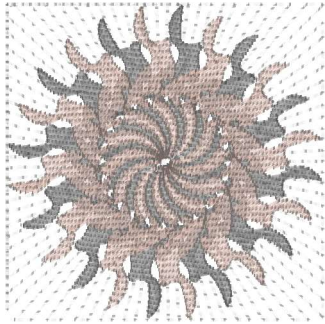

- 1. Off White (Mar:1181)
- 2. Leaden Gray (Mar:1320)
- 3. Algiers (Mar:1185)

**Design23-4x4.pes**

3.74x3.74 inches; 8,724 stitches  
3 thread changes; 3 colors

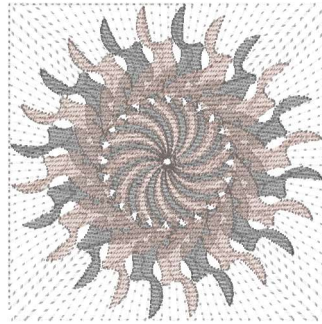

- 1. Off White (Mar:1181)
- 2. Leaden Gray (Mar:1320)
- 3. Algiers (Mar:1185)

**Design23-5x5.pes**

4.92x4.92 inches; 12,703 stitches  
3 thread changes; 3 colors

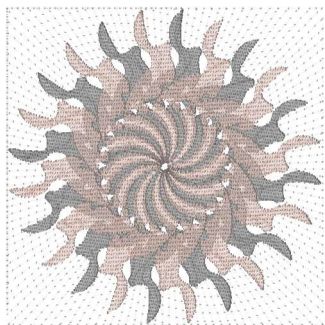

- 1. Off White (Mar:1181)
- 2. Leaden Gray (Mar:1320)
- 3. Algiers (Mar:1185)

**Design23-6x6.pes**

5.71x5.71 inches; 15,605 stitches  
3 thread changes; 3 colors

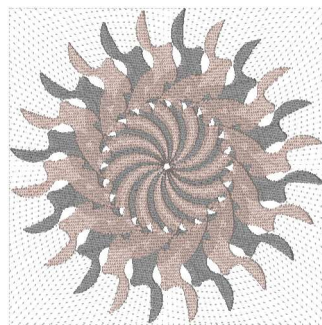

- 1. Off White (Mar:1181)
- 2. Leaden Gray (Mar:1320)
- 3. Algiers (Mar:1185)

**Design23-8x8.pes**

7.68x7.68 inches; 24,467 stitches  
3 thread changes; 3 colors

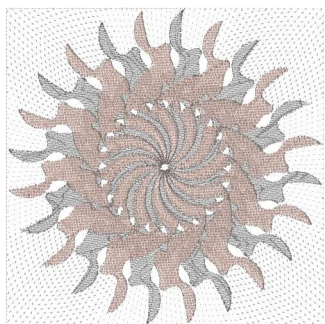

- 1. Off White (Mar:1181)
- 2. Leaden Gray (Mar:1320)
- 3. Algiers (Mar:1185)

**Design23-9x9.pes**

8.46x8.46 inches; 28,678 stitches  
3 thread changes; 3 colors

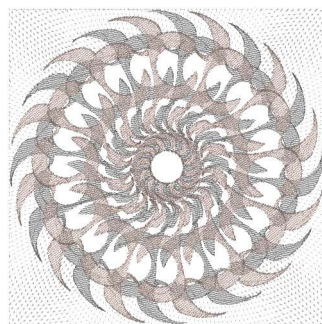

- 1. Off White (Mar:1181)
- 2. Leaden Gray (Mar:1320)
- 3. Algiers (Mar:1185)

**Design24-10x10.pes**

9.65x9.65 inches; 43,939 stitches  
3 thread changes; 3 colors

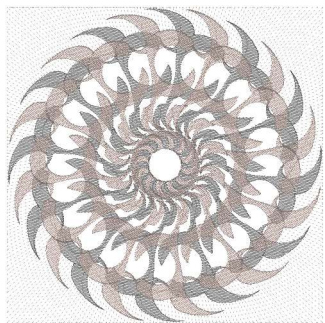

- 1. Off White (Mar:1181)
- 2. Leaden Gray (Mar:1320)
- 3. Algiers (Mar:1185)

**Design24-12x12.pes**

11.61x11.61 inches; 58,167 stitches  
3 thread changes; 3 colors

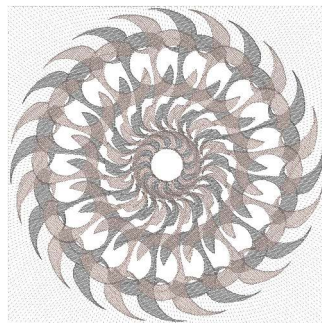

- 1. Off White (Mar:1181)
- 2. Leaden Gray (Mar:1320)
- 3. Algiers (Mar:1185)

**Design24-13x13.pes**

12.99x12.99 inches; 69,157 stitches  
3 thread changes; 3 colors

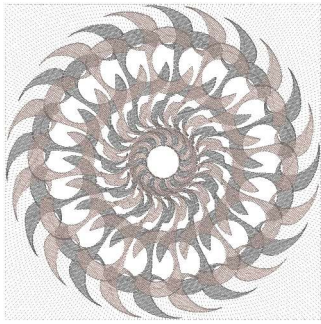

- 1. Off White (Mar:1181)
- 2. Leaden Gray (Mar:1320)
- 3. Algiers (Mar:1185)

**Design24-14x14.pes**  
13.58x13.58 inches; 74,474 stitches  
3 thread changes; 3 colors

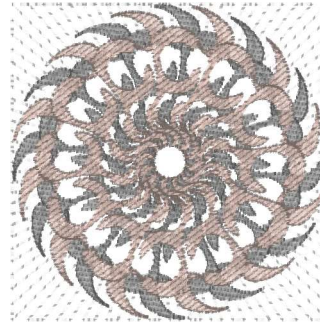

- 1. Off White (Mar:1181)
- 2. Leaden Gray (Mar:1320)
- 3. Algiers (Mar:1185)

**Design24-4x4.pes**  
3.74x3.74 inches; 12,622 stitches  
3 thread changes; 3 colors

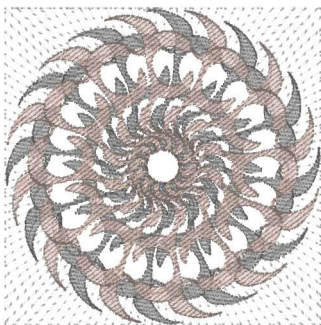

- 1. Off White (Mar:1181)
- 2. Leaden Gray (Mar:1320)
- 3. Algiers (Mar:1185)

**Design24-5x5.pes**  
4.92x4.92 inches; 17,490 stitches  
3 thread changes; 3 colors

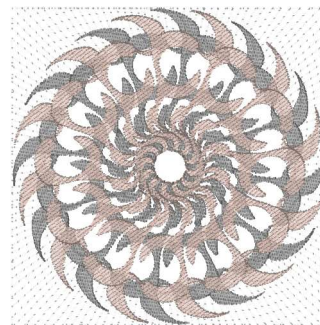

- 1. Off White (Mar:1181)
- 2. Leaden Gray (Mar:1320)
- 3. Algiers (Mar:1185)

**Design24-6x6.pes**  
5.71x5.71 inches; 21,112 stitches  
3 thread changes; 3 colors

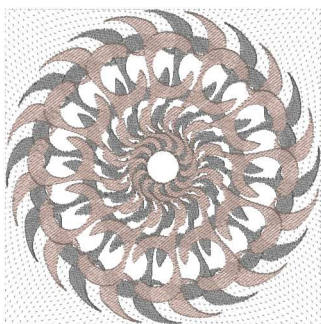

- 1. Off White (Mar:1181)
- 2. Leaden Gray (Mar:1320)
- 3. Algiers (Mar:1185)

**Design24-8x8.pes**  
7.68x7.68 inches; 31,659 stitches  
3 thread changes; 3 colors

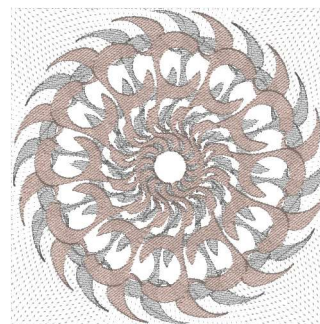

- 1. Off White (Mar:1181)
- 2. Leaden Gray (Mar:1320)
- 3. Algiers (Mar:1185)

**Design24-9x9.pes**  
8.46x8.46 inches; 36,147 stitches  
3 thread changes; 3 colors

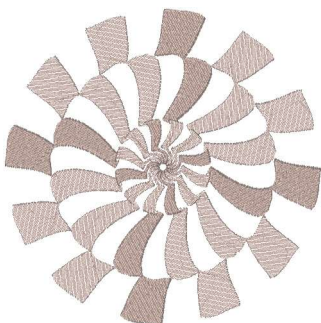

- 1. Algiers (Mar:1185)

**Design3-10x10.pes**  
9.65x9.65 inches; 29,120 stitches  
1 thread changes; 1 colors

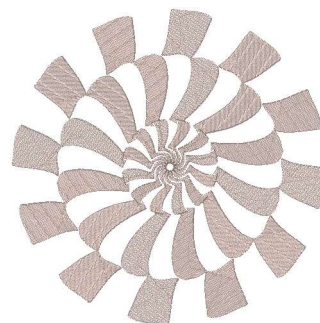

- 1. Algiers (Mar:1185)

**Design3-12x12.pes**  
11.62x11.62 inches; 39,828 stitches  
1 thread changes; 1 colors

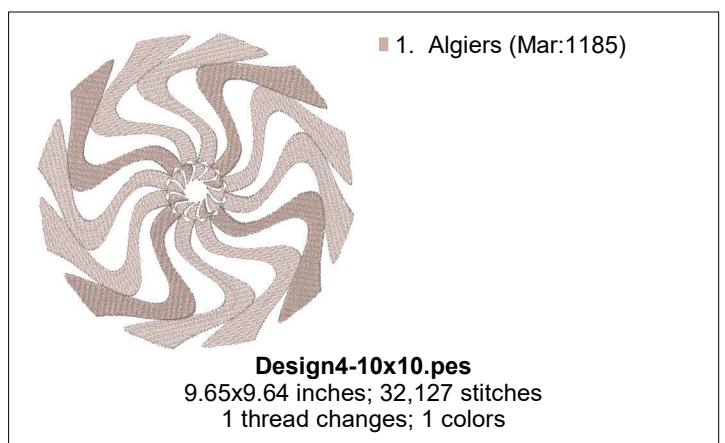
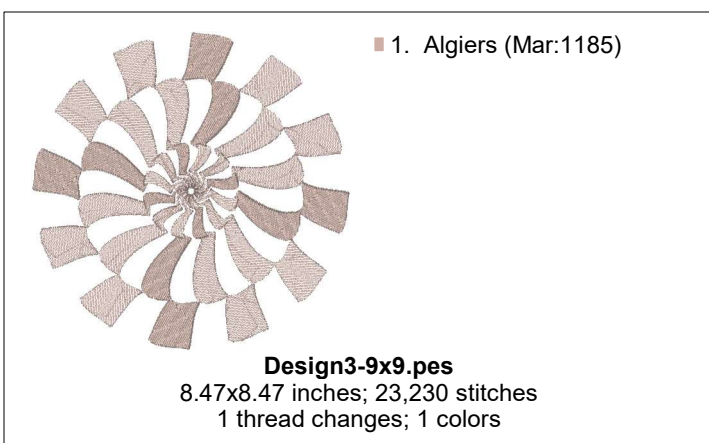
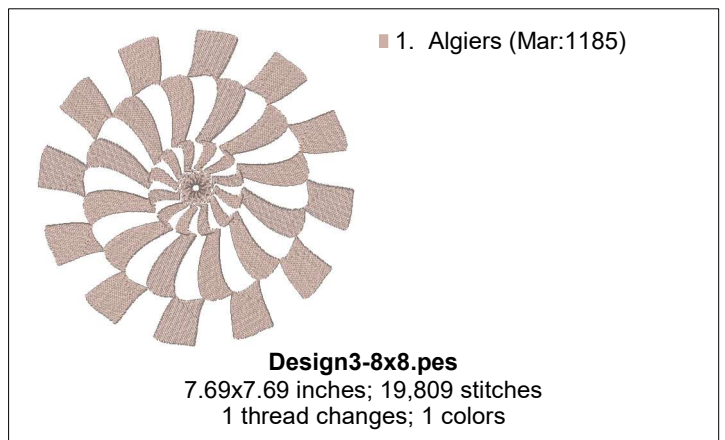
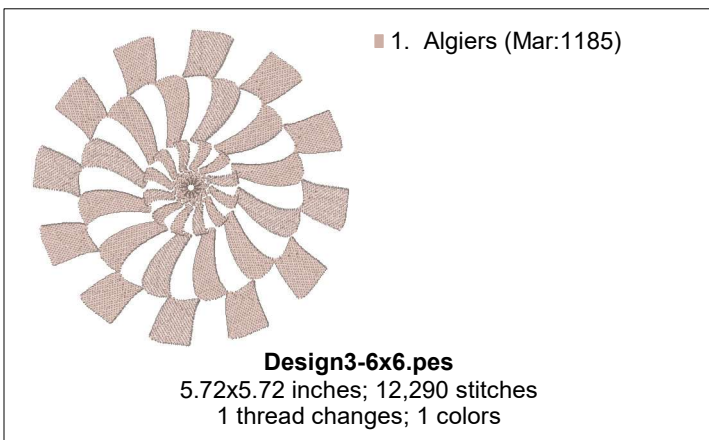
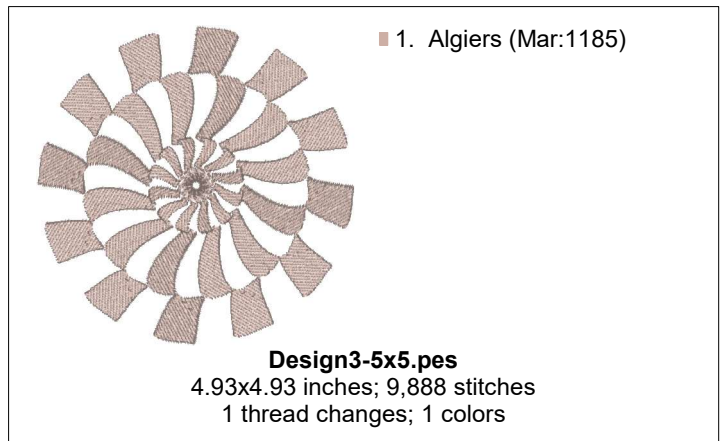
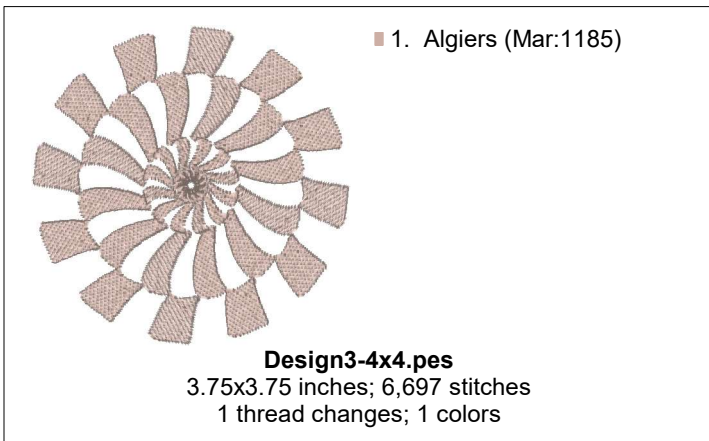
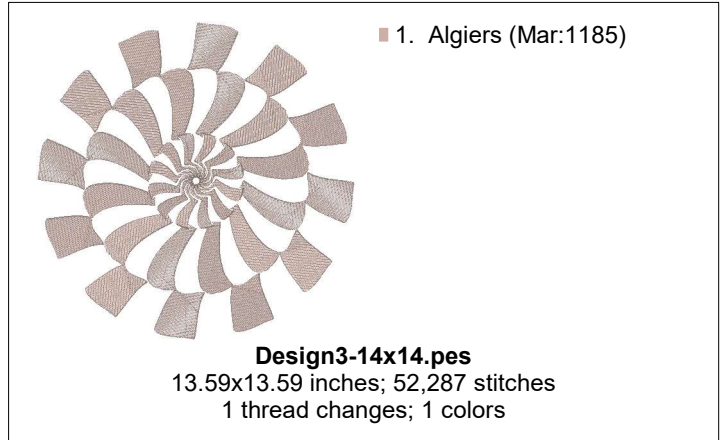
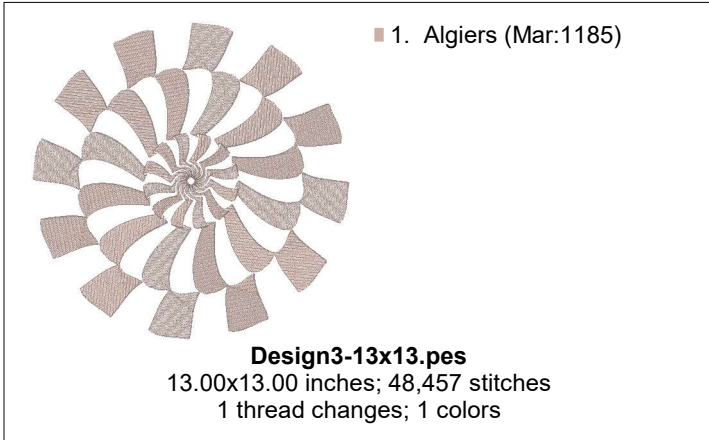

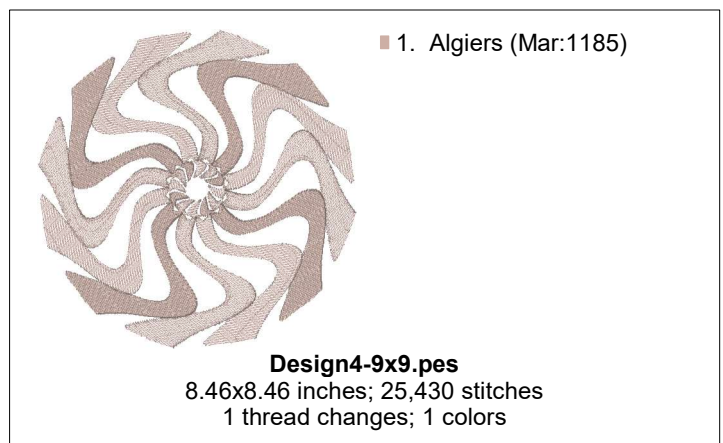
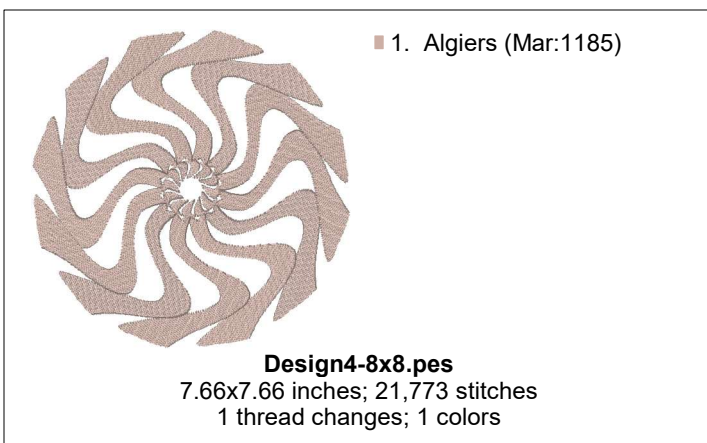
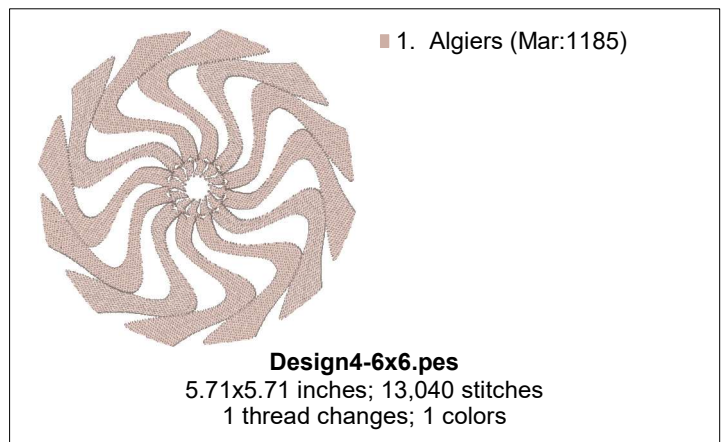
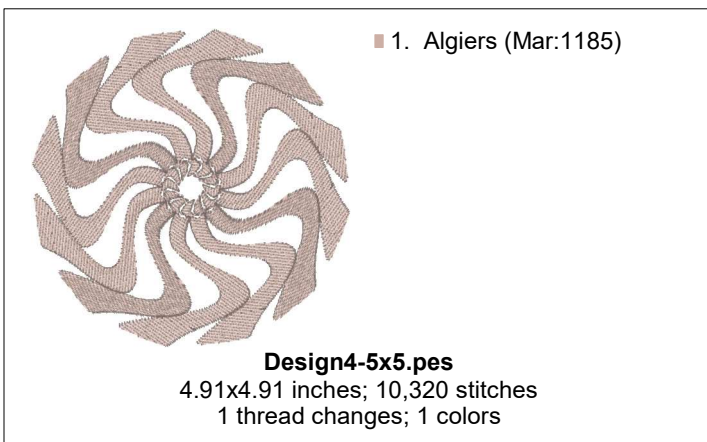
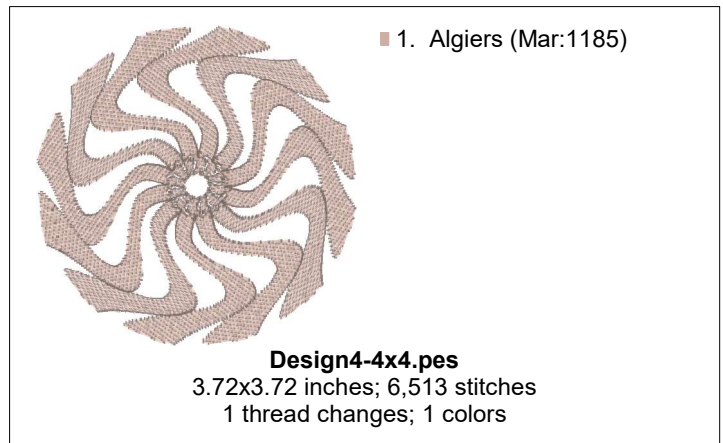
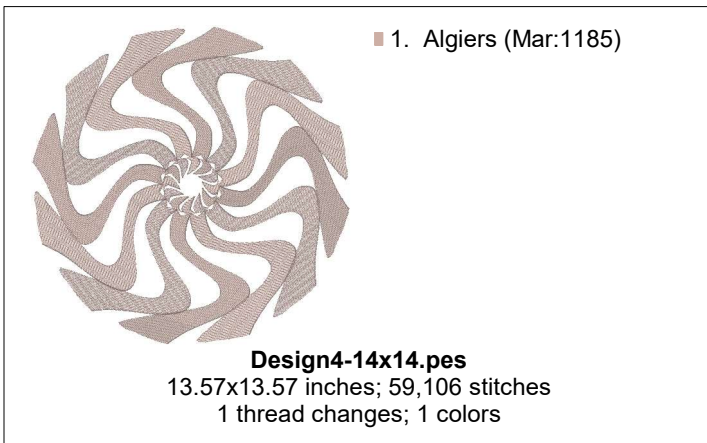
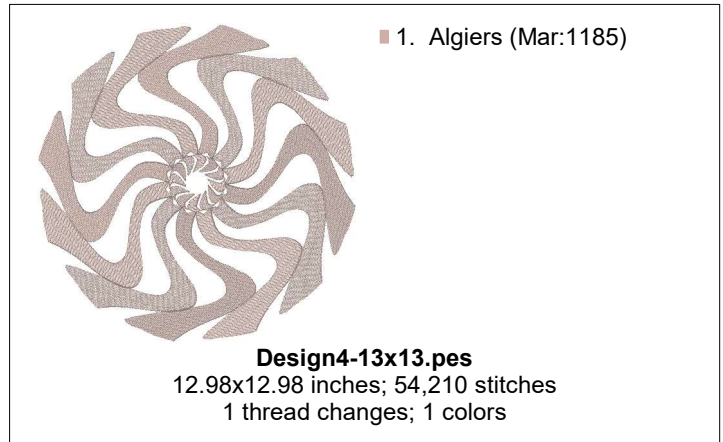
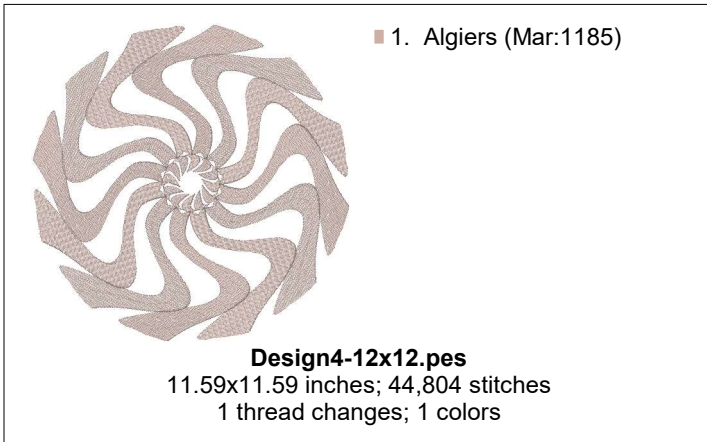

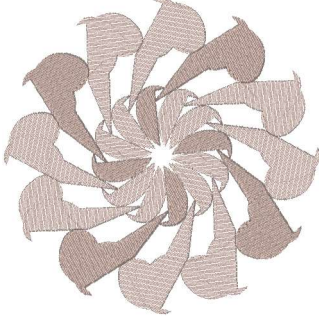

■ 1. Algiers (Mar:1185)

**Design5-10x10.pes**  
9.65x9.65 inches; 33,289 stitches  
1 thread changes; 1 colors

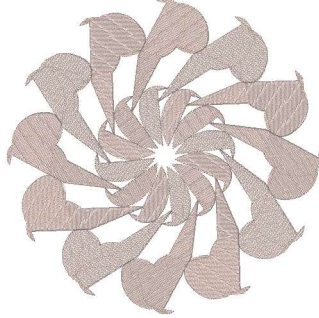

■ 1. Algiers (Mar:1185)

**Design5-12x12.pes**  
11.61x11.61 inches; 46,306 stitches  
1 thread changes; 1 colors

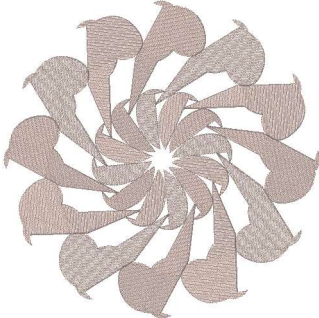

■ 1. Algiers (Mar:1185)

**Design5-13x13.pes**  
12.99x12.99 inches; 56,430 stitches  
1 thread changes; 1 colors

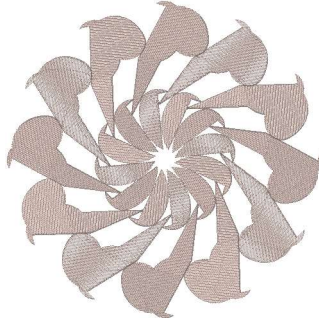

■ 1. Algiers (Mar:1185)

**Design5-14x14.pes**  
13.58x13.58 inches; 61,222 stitches  
1 thread changes; 1 colors

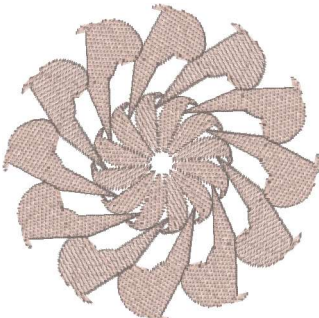

■ 1. Algiers (Mar:1185)

**Design5-4x4.pes**  
3.73x3.73 inches; 7,127 stitches  
1 thread changes; 1 colors

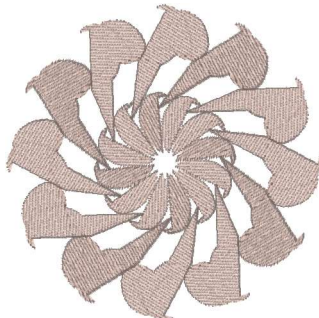

■ 1. Algiers (Mar:1185)

**Design5-5x5.pes**  
4.92x4.92 inches; 10,804 stitches  
1 thread changes; 1 colors

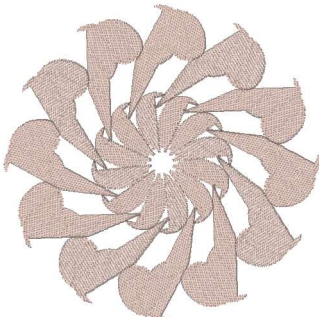

■ 1. Algiers (Mar:1185)

**Design5-6x6.pes**  
5.71x5.70 inches; 13,695 stitches  
1 thread changes; 1 colors

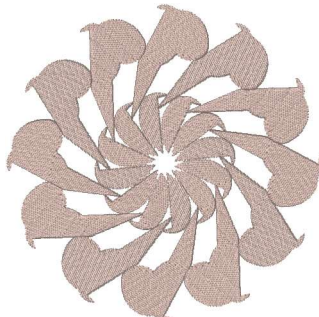

■ 1. Algiers (Mar:1185)

**Design5-8x8.pes**  
7.68x7.68 inches; 22,383 stitches  
1 thread changes; 1 colors

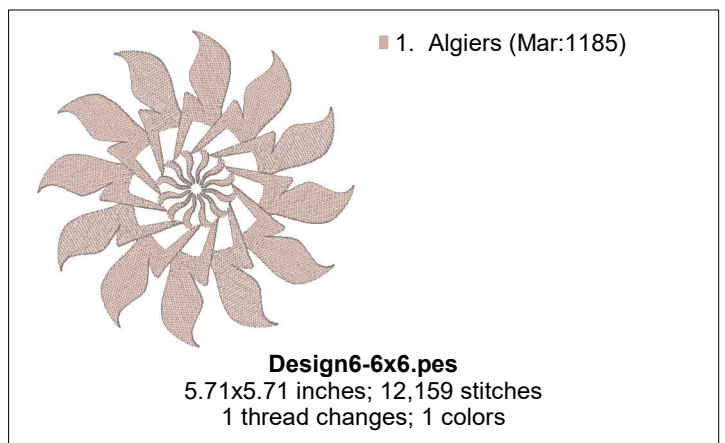
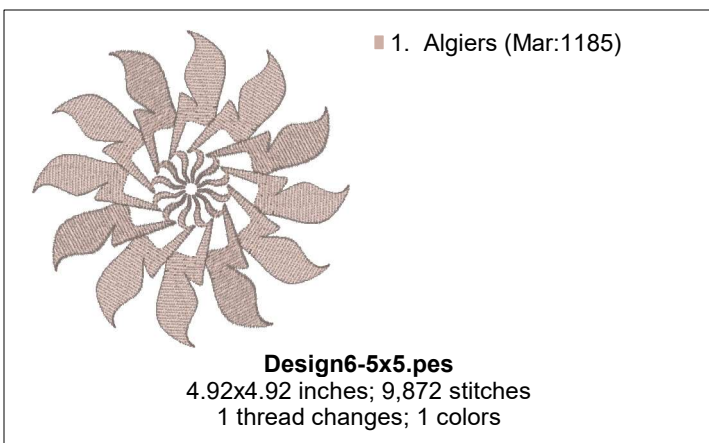
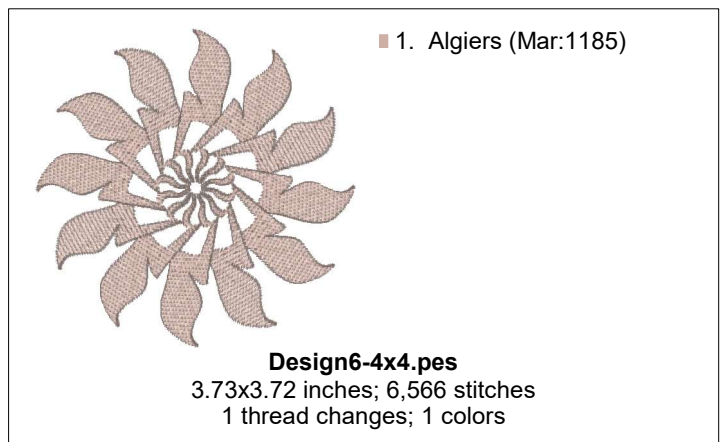
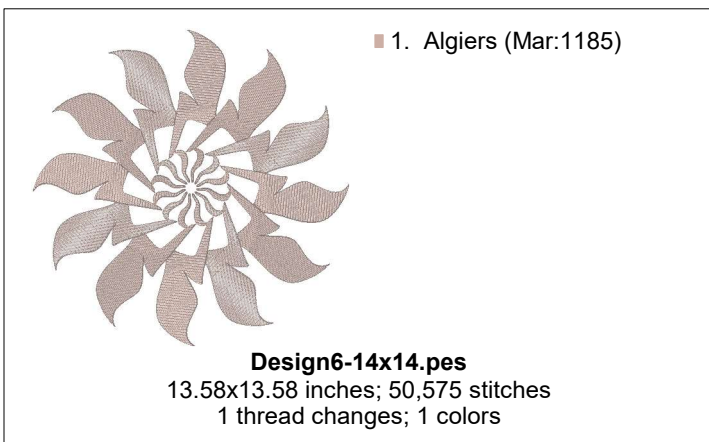
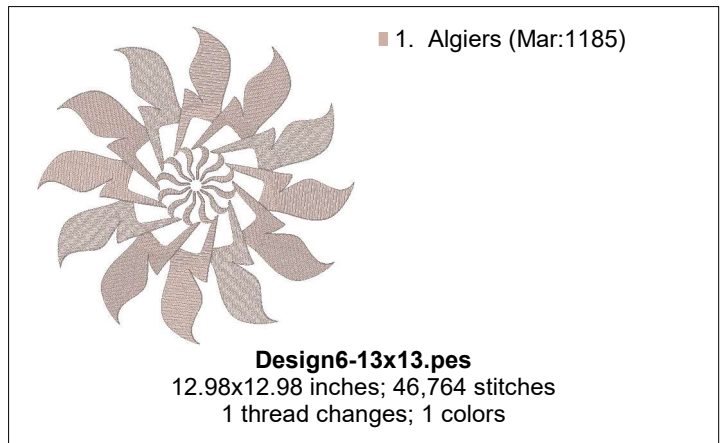
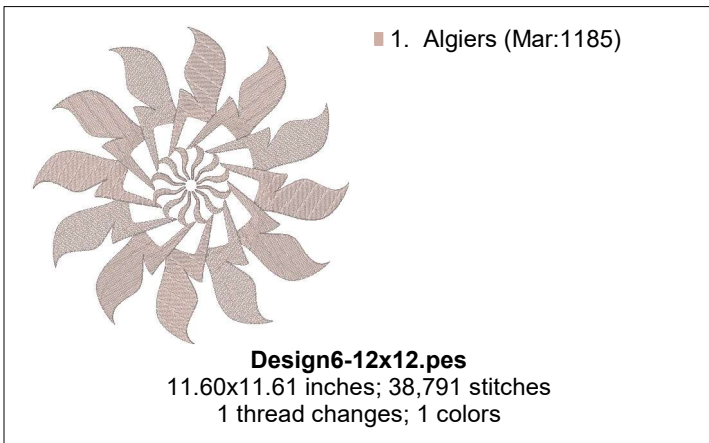
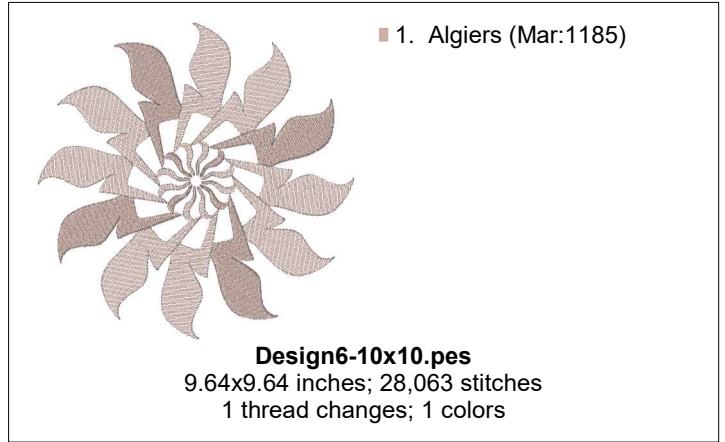
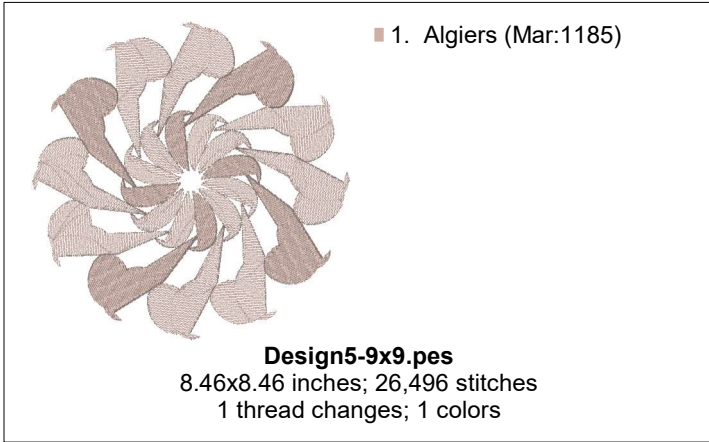

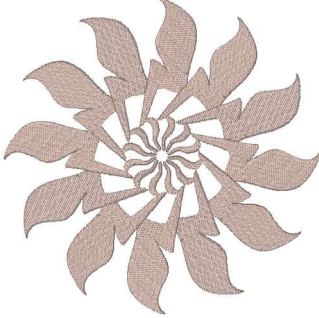

■ 1. Algiers (Mar:1185)

**Design6-8x8.pes**  
7.67x7.67 inches; 19,362 stitches  
1 thread changes; 1 colors

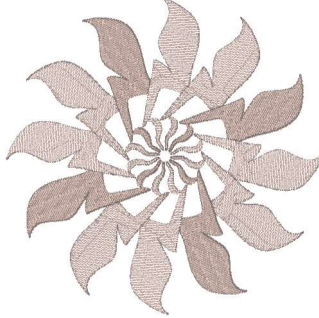

■ 1. Algiers (Mar:1185)

**Design6-9x9.pes**  
8.46x8.46 inches; 22,533 stitches  
1 thread changes; 1 colors

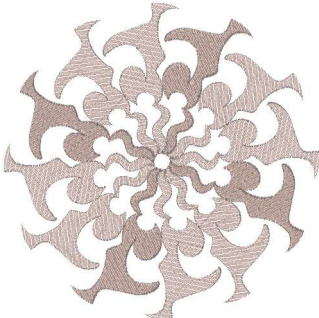

■ 1. Algiers (Mar:1185)

**Design7-10x10.pes**  
9.65x9.65 inches; 27,958 stitches  
1 thread changes; 1 colors

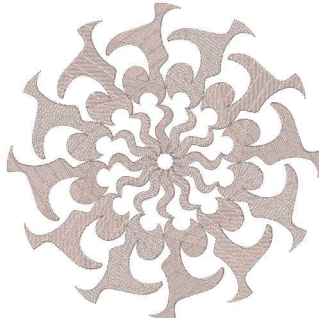

■ 1. Algiers (Mar:1185)

**Design7-12x12.pes**  
11.61x11.61 inches; 37,900 stitches  
1 thread changes; 1 colors

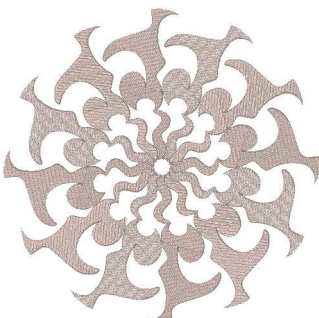

■ 1. Algiers (Mar:1185)

**Design7-13x13.pes**  
12.99x12.99 inches; 45,829 stitches  
1 thread changes; 1 colors

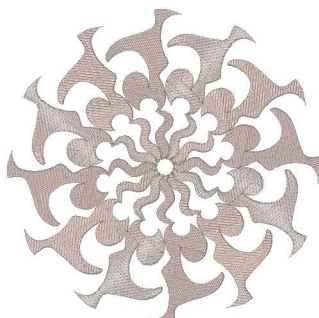

■ 1. Algiers (Mar:1185)

**Design7-14x14.pes**  
13.58x13.58 inches; 49,756 stitches  
1 thread changes; 1 colors

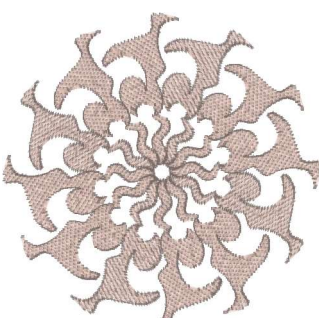

■ 1. Algiers (Mar:1185)

**Design7-4x4.pes**  
3.74x3.74 inches; 6,870 stitches  
1 thread changes; 1 colors

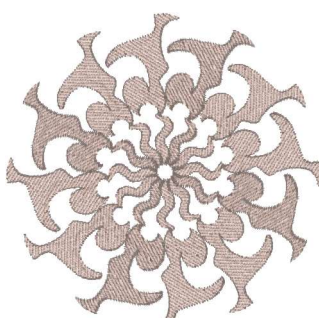

■ 1. Algiers (Mar:1185)

**Design7-5x5.pes**  
4.92x4.92 inches; 10,039 stitches  
1 thread changes; 1 colors



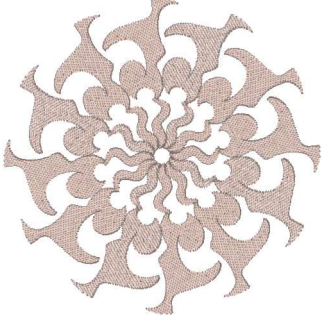

■ 1. Algiers (Mar:1185)

**Design7-6x6.pes**  
5.71x5.71 inches; 12,233 stitches  
1 thread changes; 1 colors

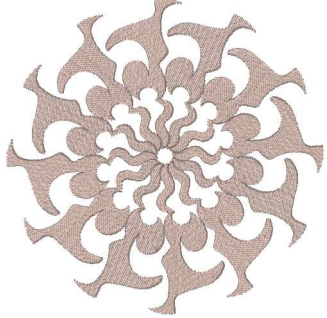

■ 1. Algiers (Mar:1185)

**Design7-8x8.pes**  
7.68x7.68 inches; 19,356 stitches  
1 thread changes; 1 colors

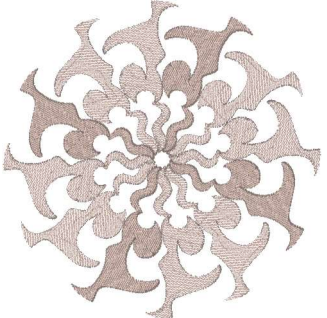

■ 1. Algiers (Mar:1185)

**Design7-9x9.pes**  
8.46x8.46 inches; 22,541 stitches  
1 thread changes; 1 colors

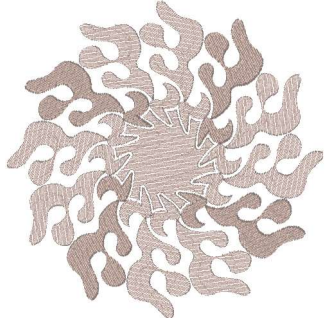

■ 1. Algiers (Mar:1185)

**Design8-10x10.pes**  
9.64x9.64 inches; 31,609 stitches  
1 thread changes; 1 colors

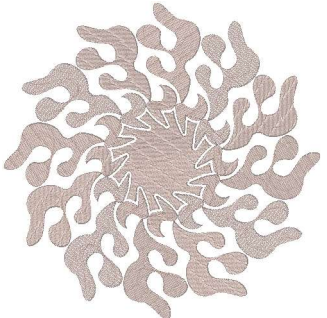

■ 1. Algiers (Mar:1185)

**Design8-12x12.pes**  
11.61x11.61 inches; 42,954 stitches  
1 thread changes; 1 colors

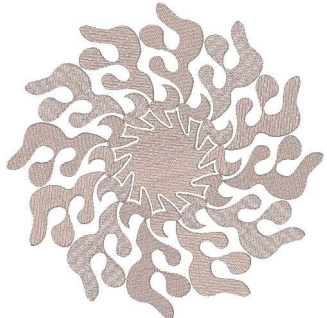

■ 1. Algiers (Mar:1185)

**Design8-13x13.pes**  
12.98x12.99 inches; 51,880 stitches  
1 thread changes; 1 colors

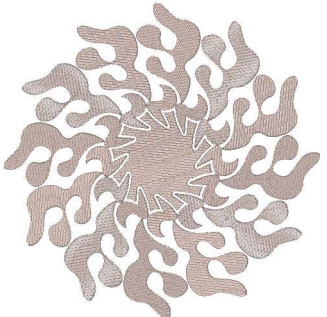

■ 1. Algiers (Mar:1185)

**Design8-14x14.pes**  
13.58x13.58 inches; 56,047 stitches  
1 thread changes; 1 colors

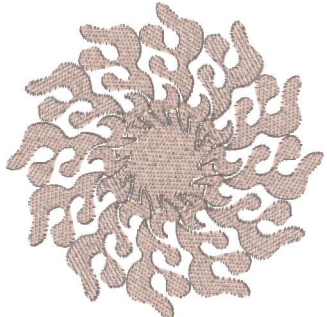

■ 1. Algiers (Mar:1185)

**Design8-4x4.pes**  
3.74x3.74 inches; 7,617 stitches  
1 thread changes; 1 colors

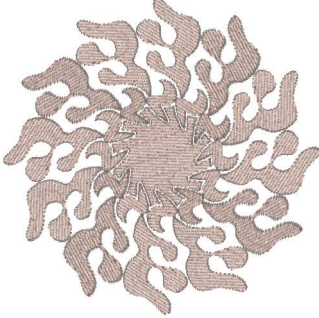

■ 1. Algiers (Mar:1185)

**Design8-5x5.pes**  
4.92x4.92 inches; 11,244 stitches  
1 thread changes; 1 colors

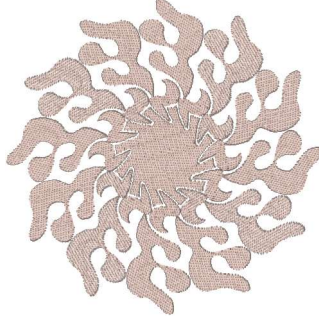

■ 1. Algiers (Mar:1185)

**Design8-6x6.pes**  
5.70x5.71 inches; 13,778 stitches  
1 thread changes; 1 colors

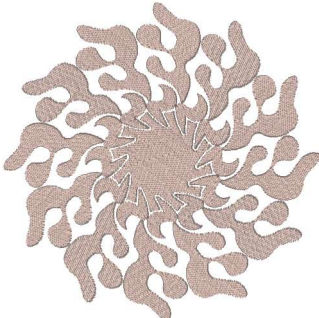

■ 1. Algiers (Mar:1185)

**Design8-8x8.pes**  
7.67x7.67 inches; 21,814 stitches  
1 thread changes; 1 colors

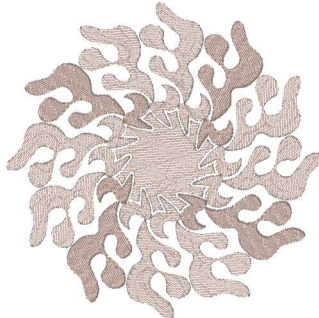

■ 1. Algiers (Mar:1185)

**Design8-9x9.pes**  
8.46x8.46 inches; 25,446 stitches  
1 thread changes; 1 colors

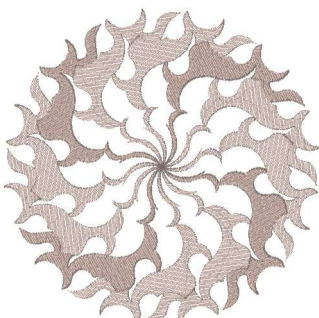

■ 1. Algiers (Mar:1185)

**Design9-10x10.pes**  
9.61x9.61 inches; 30,950 stitches  
1 thread changes; 1 colors

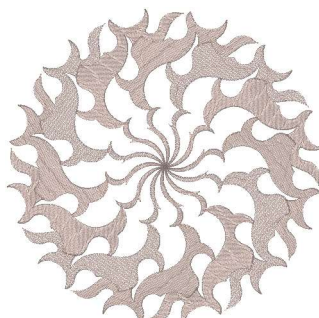

■ 1. Algiers (Mar:1185)

**Design9-12x12.pes**  
11.59x11.59 inches; 41,788 stitches  
1 thread changes; 1 colors

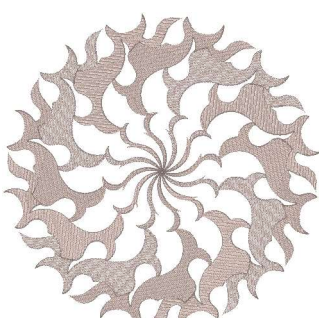

■ 1. Algiers (Mar:1185)

**Design9-13x13.pes**  
12.99x12.99 inches; 49,956 stitches  
1 thread changes; 1 colors

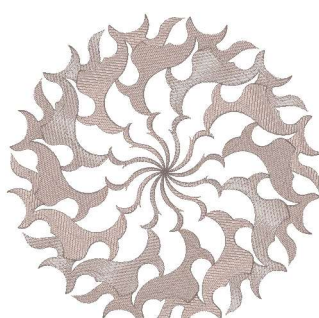

■ 1. Algiers (Mar:1185)

**Design9-14x14.pes**  
13.57x13.57 inches; 54,696 stitches  
1 thread changes; 1 colors

